



NEW!
Papyrus™
See page 55



BELGARD®
PAVES THE WAY®

LIFETIME TRANSFERABLE LIMITED WARRANTY

Oldcastle® APG, Inc. ("Belgard") is proud to inform you that all of our interlocking concrete paver and retaining walls ("Products") meet and/or exceed the requirements of ASTM C-936 and ASTM C-1372. Belgard® guarantees its Products against these standards for the lifetime of the Product defined by CMHA. This guarantee does not apply to splitting, chipping or other breakage that could be caused by impact, abrasion or overloading. This warranty is transferable. The original proof of purchase is required.

This warranty is only valid if the material is installed under the guidelines of CMHA (masonryandhardscapes.org) or the Belgard Installation Guideline Manual. Improper installation voids this warranty. This warranty is for residential applications only and does not apply to commercial applications. It is recommended that the job be installed by a Belgard Authorized Contractor participant who guarantees their workmanship for a minimum of 3 years from the date of install. For warranty service, contact Belgard at 877-BELGARD. A service representative will investigate your claim within 10 business days. If the Belgard product fails to meet the specifications, Belgard will replace the defective product at no charge. Color matching cannot be guaranteed. Belgard will not be responsible for any replacement labor, consequential damages or incidental damages. This warranty gives you specific legal rights, and you may also have other rights which vary from state to state. Some states do not allow for the exclusion or limitation of incidental or consequential damages, so the above limitation or exclusion may not apply to you.

For specific information regarding warranty coverage and exclusions in regards to the Elements™ and Porcelain Paver products, please visit: Belgard.com/Warranty.

ABOUT US

At Belgard®, we take our role as industry leaders seriously. Our rigorous research and development program is centered on innovation and quality. We never take it for granted that our products are the best in the business and constantly strive to improve and take the industry to the next level. Our overarching goal is to continue to find new and exciting ways to create beautiful outdoor spaces while maintaining incredibly high standards for product quality and performance.

Since 1995, our locally made and nationally backed products have transformed thousands of residential and commercial properties across North America. With more shapes, styles and textures than any other brand, Belgard's Outdoor Living paving and wall products aren't just functional, they infuse outdoor spaces with distinctive atmosphere and style.

Every day, our network of Belgard Authorized Dealers and Contractors helps customers realize their outdoor dreams. And every year, we strive to improve our product and service offerings by dedicating more than 20,000 hours to research and development. By staying ahead of design trends, we are able to provide design-forward products that homeowners envision for their backyard spaces.

All of our outdoor products—when installed by a Belgard Authorized Contractor—are covered by a transferable lifetime limited warranty. That's just part of our commitment to lasting outdoor beauty.

PAVERS & SLABS

PAVERS & SLABS INSTALLATION GUIDE

04 Interlocking Concrete Pavement

PAVERS & SLABS

05	Avalon Slate	33	Empire™
07	Basalt™	35	Geometric Shapes
09	Brooklyn™	37	Holland Stone
11	Cambridge Cobble® & Circle Kit	39	Mega-Arbel®
15	Catalina Grana®	41	Melville™ Plank
17	Dimensions™ 6, 12, 18	45	Origins™ 6, 12, 18
19	Dimensions™ Accent	47	Origins™ Accent
20	Dimensions™ Plank	54	Origins™ Antiqued
27	Dimensions™ Slab	55	Papyrus™
30	Dublin Cobble®		

For basic paver installation information
visit masonryandhardscapes.org

INTERLOCKING CONCRETE PAVEMENT (ICP)

PATIO/WALK/RESIDENTIAL DRIVEWAY WITH PLASTIC EDGE RESTRAINT CROSS SECTION

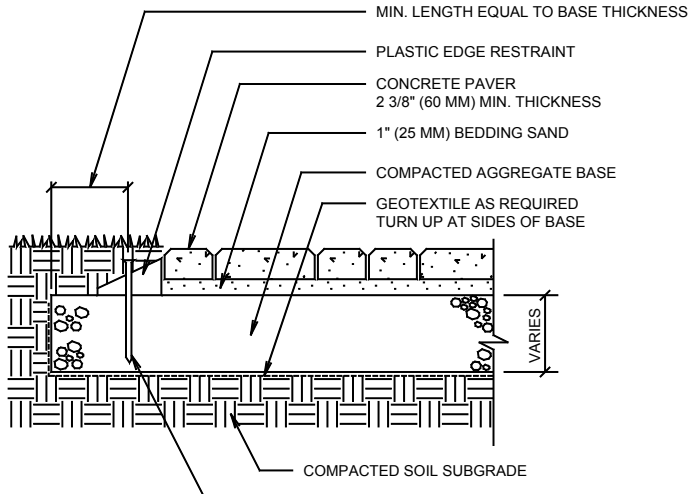

RESIDENTIAL DRIVEWAY WITH CONCRETE EDGES CROSS SECTION

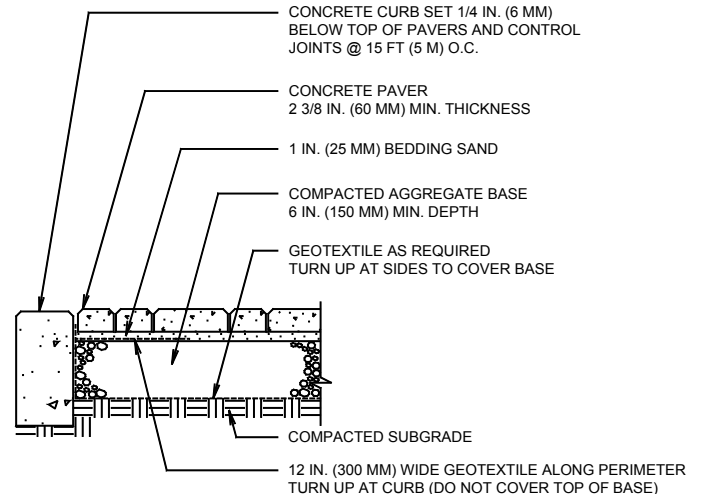

PATIO/SIDEWALK ON COMPACTED AGGREGATE BASE CROSS SECTION

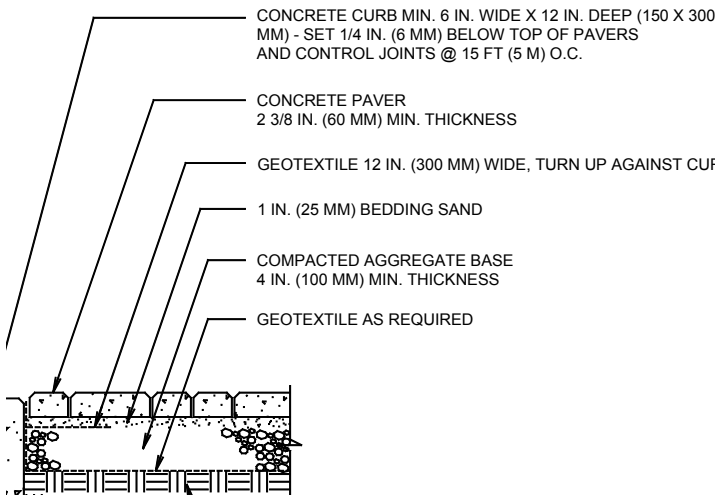

SWIMMING POOL DECK AND COPING CROSS SECTION

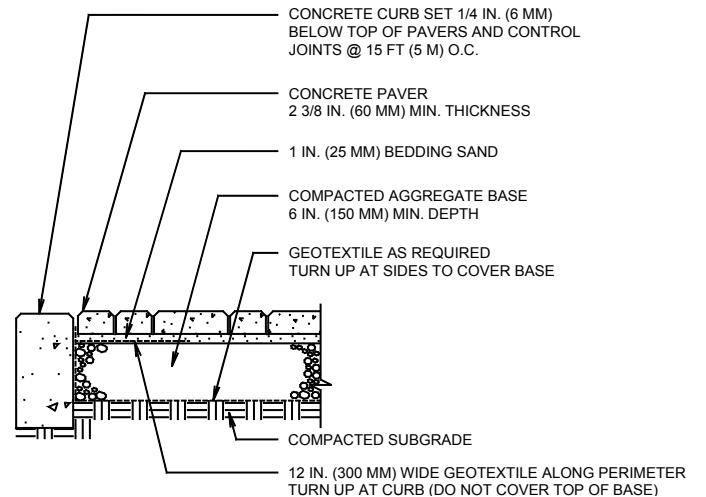







AVALON SLATE



Scan for additional
product information

**Special Order
Contact your Belgard representative for more information.*

PEDESTRIAN	LIGHT/REGULAR TRAFFIC	HEAVY TRAFFIC	CORE MIX	DURAFUSION PROCESS	ADA	FINISHES		
						SHOT BLAST	GROUND FACE	TUMBLED/ ANTIQUED
✓	✓		✓	✓		✓*		✓*

SHAPES & SIZES

3-Piece Large | 60MM

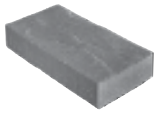

6 x 12 x 2³/₈

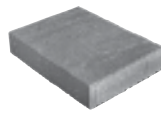

9 x 12 x 2³/₈

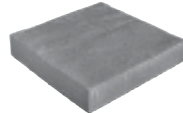

12 x 12 x 2³/₈

UNIT	SQFT/ PALLET	SQFT/ LAYER	LAYER/ PALLET	UNITS/ PALLET	UNITS/ LAYER	UNITS/ SQFT	WEIGHT/ PALLET
------	-----------------	----------------	------------------	------------------	-----------------	----------------	-------------------

3-PIECE LARGE

6 X 12 X 2 ³ / ₈	30	3	–	60	6	2	807.5
9 X 12 X 2 ³ / ₈	30	3	–	40	4	1.33	807.5
12 X 12 X 2 ³ / ₈	60	6	–	60	6	1	1614.6
TOTAL	120	12	10	160	16	–	3230



NOTES:

AutoCAD® hatch pattern files can be downloaded from belgard.com for use in architectural drawings.

Some patterns may not necessarily reflect the percentages of stone sizes within a particular pallet. In some cases you may have extras in one or more of the sizes. This must be accounted for in your planning and design.

Percentages are estimated based on area by paver.

25% 6 x 12 Rectangles





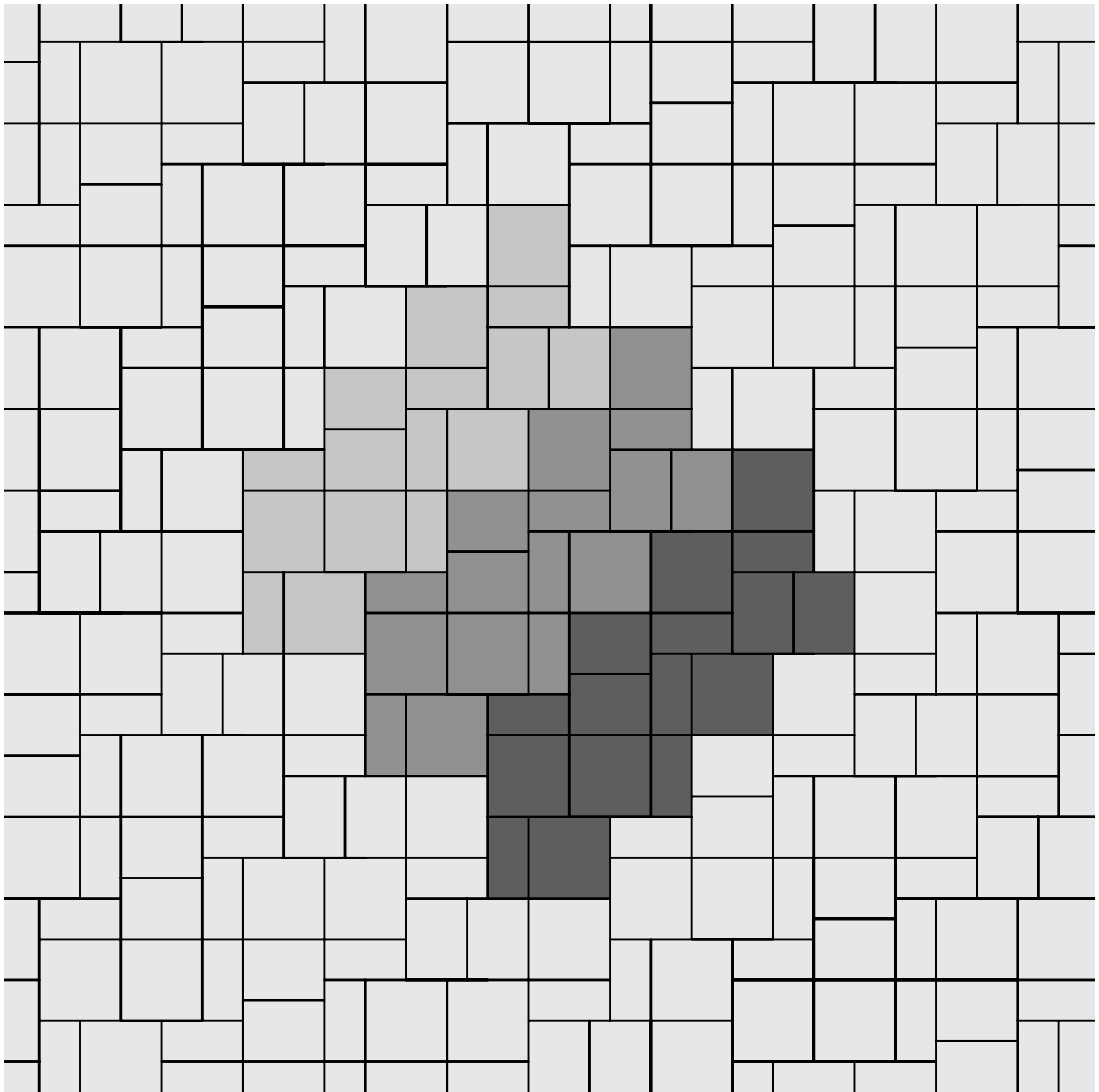

25% 9 x 12 Rectangles

50% 12 x 12 Squares





Scan for additional
product information

PEDESTRIAN	LIGHT/REGULAR TRAFFIC	HEAVY TRAFFIC	CORE MIX	DURAFUSION PROCESS	ADA
					
✓			✓	✓	✓

SHAPES & SIZES

3-Piece



9 x 18 x 2³/₈

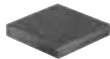

18 x 18 x 2³/₈

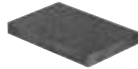

18 x 27 x 2³/₈

UNIT	SQFT/ PALLET	SQFT/ LAYER	LAYER/ PALLET	UNITS/ PALLET	UNITS/ LAYER	UNITS/ SQFT	WEIGHT/ PALLET
3-PIECE							
9 X 18 X 2³/₈	22.5	2.25	10	20	2	.88	627.4
18 X 18 X 2³/₈	22.5	2.25	10	10	1	.44	286
18 X 27 X 2³/₈	67.5	6.75	10	20	2	.29	1894
TOTAL	112.5	11.25	10	50	5	–	3152



NOTES:

AutoCAD® hatch pattern files can be downloaded from belgard.com for use in architectural drawings.

Some patterns may not necessarily reflect the percentages of stone sizes within a particular pallet. In some cases you may have extras in one or more of the sizes. This must be accounted for in your planning and design.

Percentages are based on area by paver.

3-PIECE MIXED PATTERN

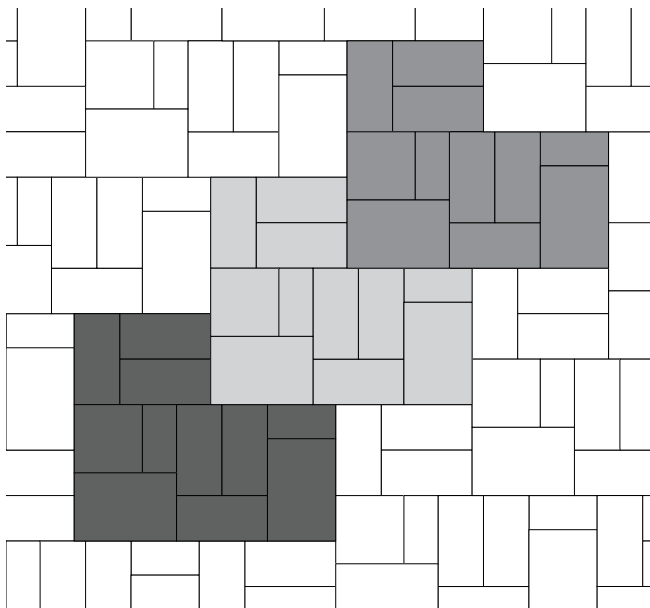

3-PIECE HERRINGBONE PATTERN

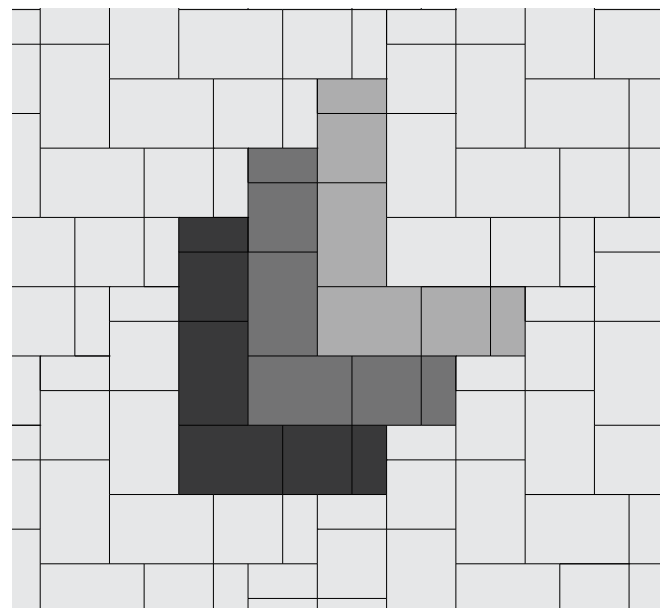



Scan for additional
product information

PEDESTRIAN	LIGHT/REGULAR TRAFFIC	HEAVY TRAFFIC	CORE MIX	DURAFUSION PROCESS	ADA
✓	✓		✓	✓	✓

SHAPES & SIZES

60mm



3 x 9 x 2³/₈

UNIT	SQFT/ PALLET	SQFT/ LAYER	LAYER/ PALLET	UNITS/ PALLET	UNITS/ LAYER	SQFT/ UNIT	WEIGHT/ PALLET
60MM							
3 X 9 X 2³/₈	103.13	10.3	10	550	55	5.3	2806

NOTES:

AutoCAD® hatch pattern files can be downloaded from belgard.com for use in architectural drawings.

Some patterns may not necessarily reflect the percentages of stone sizes within a particular pallet. In some cases you may have extras in one or more of the sizes. This must be accounted for in your planning and design.

Percentages are based on area by paver.

1-PIECE RUNNING BOND PATTERN

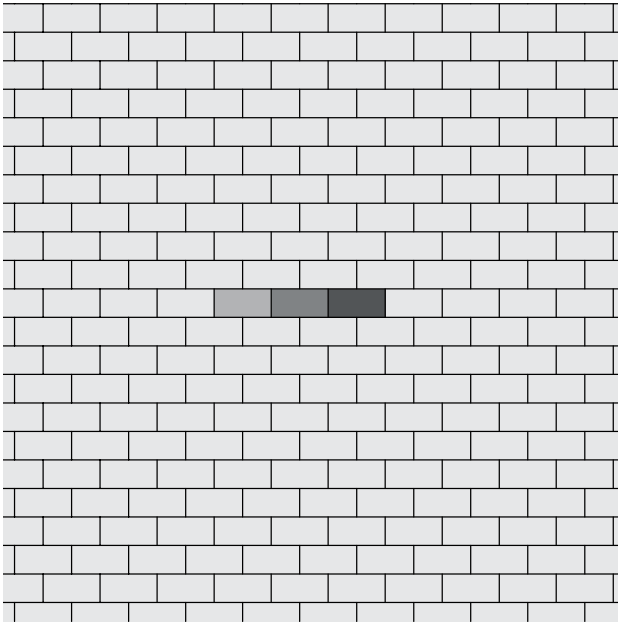

1-PIECE HERRINGBONE PATTERN

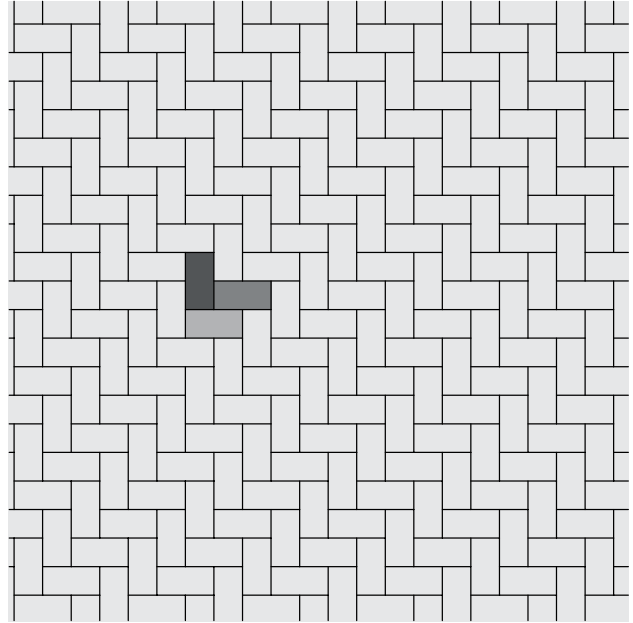

1-PIECE BASKET WEAVE PATTERN

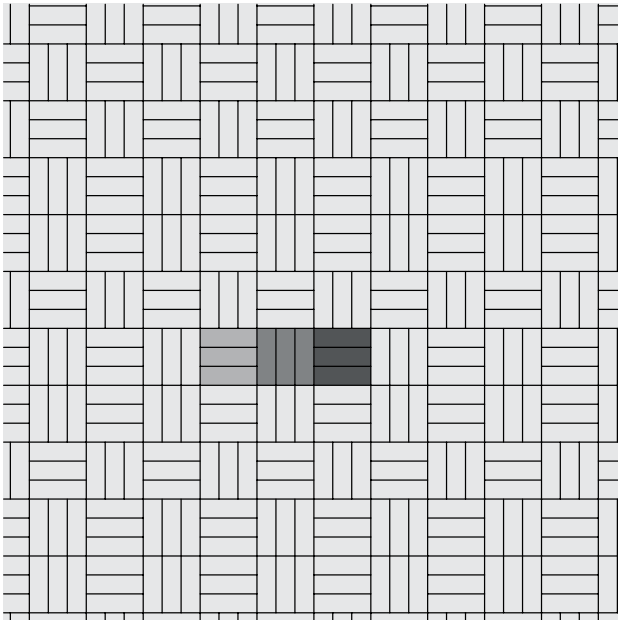







CAMBRIDGE COBBLE® & CIRCLE KIT







Scan for additional product information

*Finishes and 80MM Special Order Only
Contact your local Belgard representative for more information.

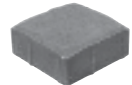
PEDESTRIAN	LIGHT/REGULAR TRAFFIC	HEAVY TRAFFIC	CORE MIX	DURAFUSION PROCESS	ADA	FINISHES		
						SHOT BLAST	GROUND FACE	TUMBLED/ ANTIQUED
✓	✓	✓*	✓	✓		✓*		✓*

SHAPES & SIZES

Square	Rectangle	Large Rectangle	Circle Kit
			
6 x 6 x 1 ³ / ₁₆ (30mm) 6 x 6 x 2 ³ / ₈ (60mm) 6 x 6 x 3 ¹ / ₈ (80mm)*	6 x 9 x 1 ³ / ₁₆ (30mm) 6 x 9 x 2 ³ / ₈ (60mm) 6 x 9 x 3 ¹ / ₈ (80mm)*	9 x 12 x 2 ³ / ₈	5 ⁷ / ₈ x Variable x 2 ³ / ₈

UNIT	SQFT/ PALLET	SQFT/ LAYER	LAYER/ PALLET	UNITS/ PALLET	UNITS/ LAYER	UNITS/ SQFT	WEIGHT/ PALLET
------	--------------	-------------	---------------	---------------	--------------	-------------	----------------

CAMBRIDGE COBBLE

6 X 6 X 1 ³ / ₁₆	120	12	10	480	48	4	1650
6 X 6 X 2 ³ / ₈	120	12	10	480	48	4	3230
6 X 6 X 3 ¹ / ₈	96	12	8	384	48	4	3580
6 X 9 X 1 ³ / ₁₆	112	11.2	10	300	30	2.67	1540
6 X 9 X 2 ³ / ₈	112	11.2	10	300	30	2.67	3020
6 X 9 X 3 ¹ / ₈	90	11.25	8	240	30	2.67	3360
9 X 12 X 2 ³ / ₈	120	12	10	160	16	1.33	3086
5 ⁷ / ₈ X VARIABLE X 2 ³ / ₈	78.5	7.85	10	–	–	–	2140

NOTES:

AutoCAD® hatch pattern files can be downloaded from belgard.com for use in architectural drawings.

Some patterns may not necessarily reflect the percentages of stone sizes within a particular pallet. In some cases you may have extras in one or more of the sizes. This must be accounted for in your planning and design.

Percentages are estimated based on area by paver.

25% 6 x 6 Squares

75% 6 x 9 Rectangles

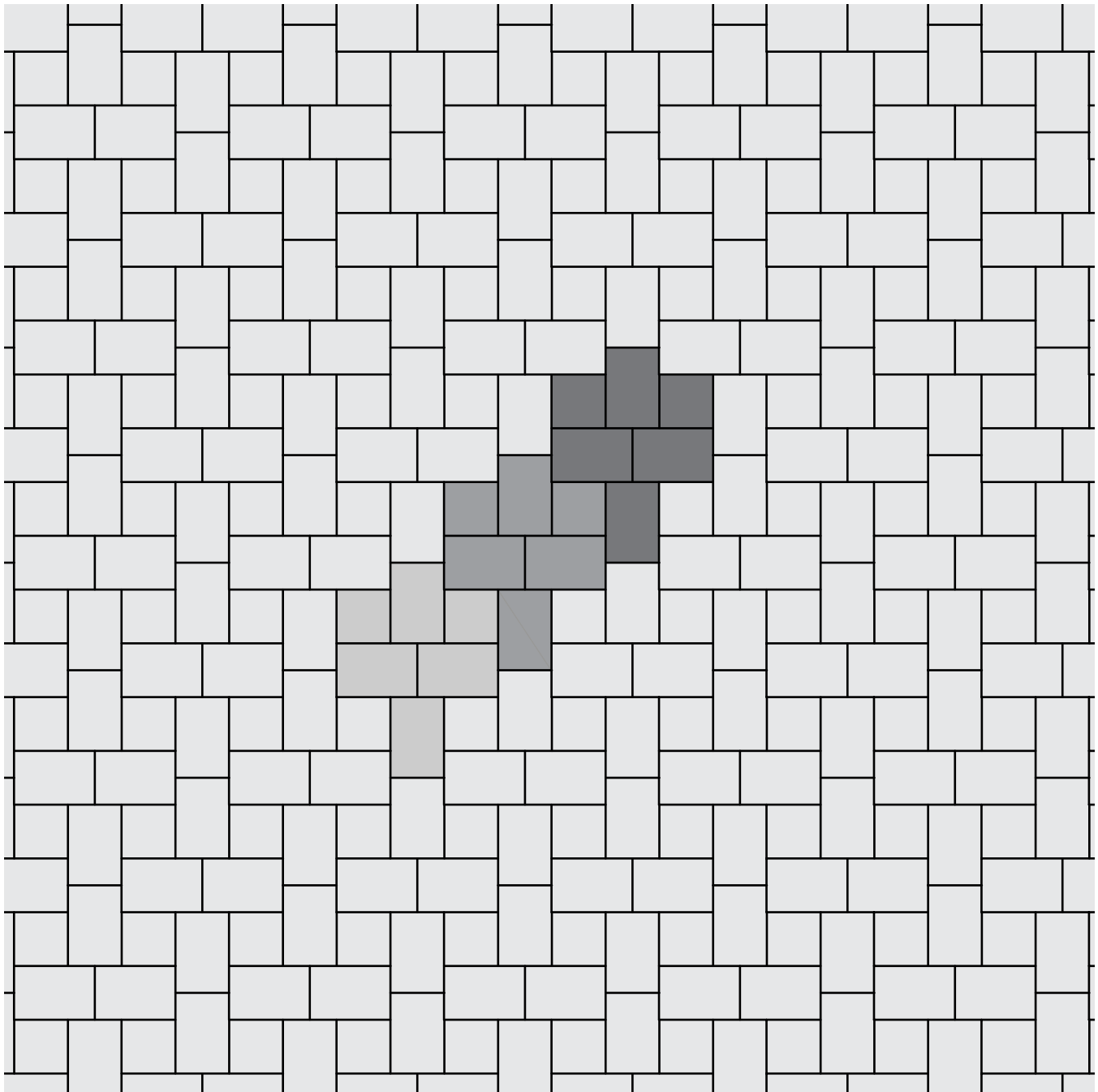

NOTES:

AutoCAD® hatch pattern files can be downloaded from belgard.com for use in architectural drawings.

Some patterns may not necessarily reflect the percentages of stone sizes within a particular pallet. In some cases you may have extras in one or more of the sizes. This must be accounted for in your planning and design.

Percentages are estimated based on area by paver.

10% 6 x 6 Squares

30% 6 x 9 Rectangles

60% 9 x 12 Rectangles

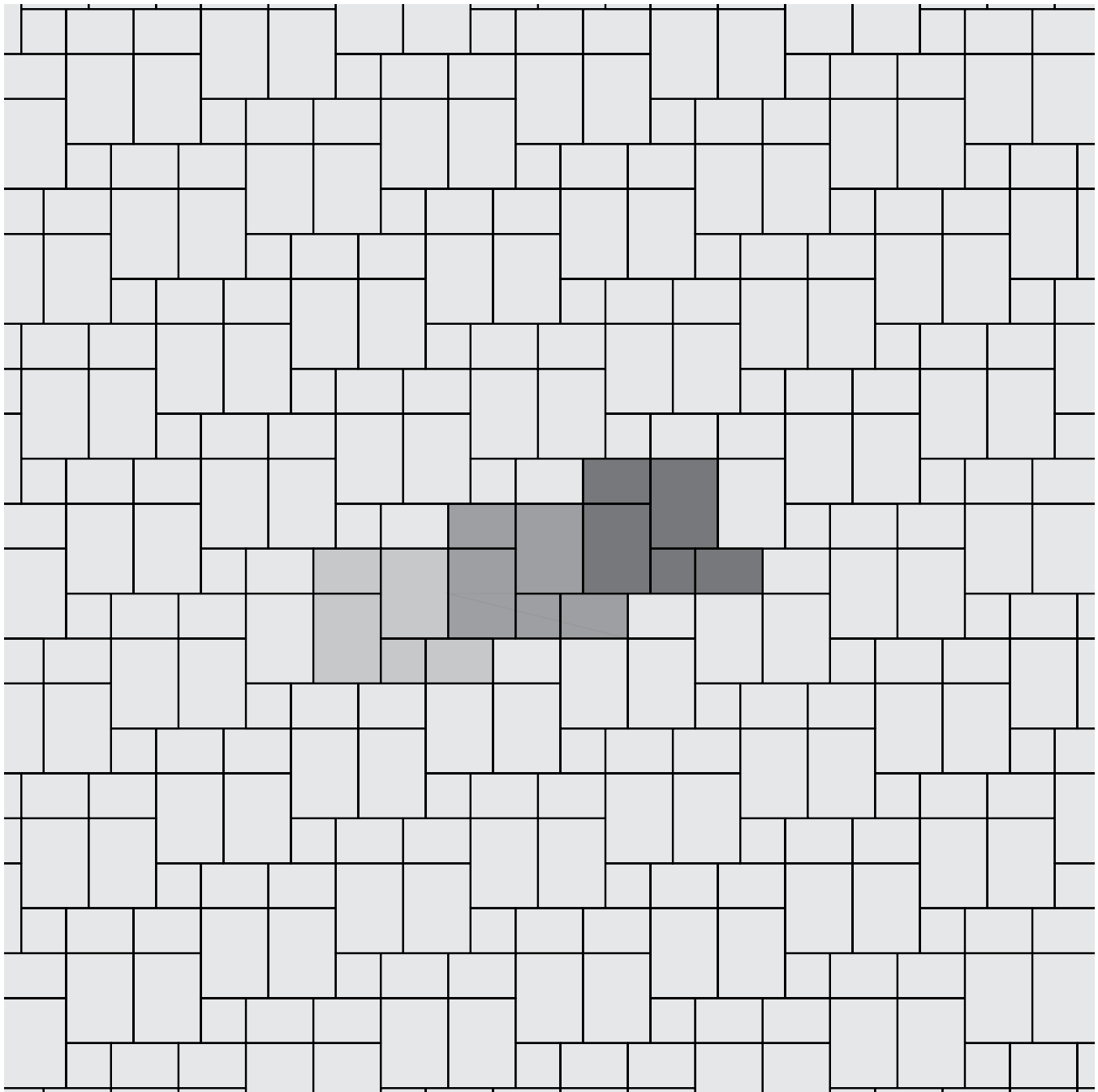

NOTES:

AutoCAD® hatch pattern files can be downloaded from belgard.com for use in architectural drawings.

Some patterns may not necessarily reflect the percentages of stone sizes within a particular pallet. In some cases you may have extras in one or more of the sizes. This must be accounted for in your planning and design.

Percentages are estimated based on area by paver.

6 x Variable x 2³/₈

Installation Guidelines

- 1) Start by marking out circles on the surface to be paved.
- 2) Determine the dimensions of each concentric circle, as well as the layout details.
- 3) Always lay pavers starting from the center.
- 4) For a semicircle or quarter circle, follow the same laying order.

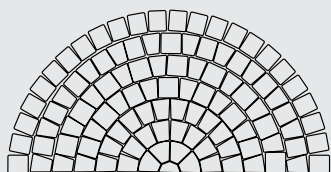

Half Circle

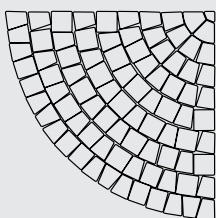

Quarter Round

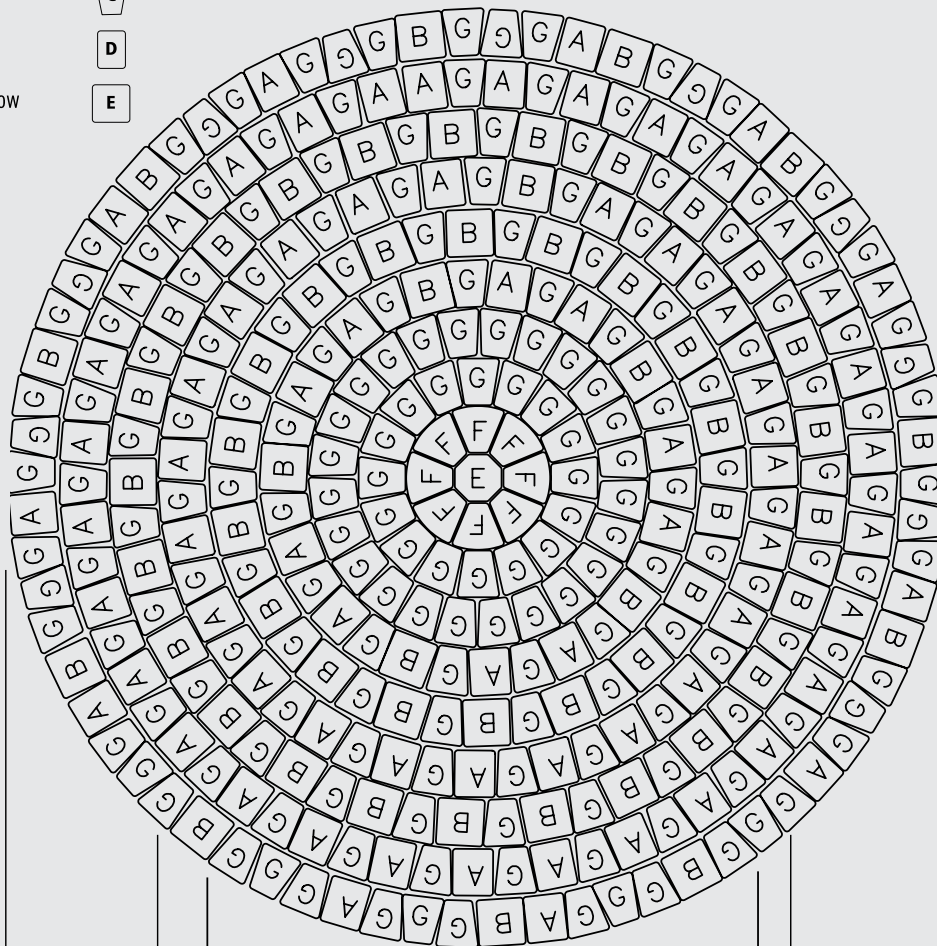







2 circles at 6.5 ft.

1 circle at 9 ft.



Scan for additional
product information

**Special Order Only*
Contact your local Belgard representative for more information.

PEDESTRIAN	LIGHT/REGULAR TRAFFIC	HEAVY TRAFFIC	CORE MIX	DURAFUSION PROCESS	ADA	FINISHES		
						SHOT BLAST	GROUND FACE	TUMBLED/ ANTIQUED
✓	✓		✓	✓	✓	✓*	✓*	✓*

SHAPES & SIZES

3-Piece Large

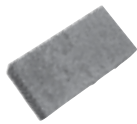

6 x 12 x 2³/₈

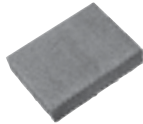

9 x 12 x 2³/₈

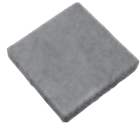

12 x 12 x 2³/₈

UNIT	SQFT/ PALLET	SQFT/ LAYER	LAYER/ PALLET	UNITS/ PALLET	UNITS/ LAYER	UNITS/ SQFT	WEIGHT/ PALLET
3-PIECE LARGE							
6 X 12 X 2³/₈	30	3	–	60	6	2	807.50
9 X 12 X 2³/₈	30	3	–	40	4	1.33	807.50
12 X 12 X 2³/₈	60	6	–	60	6	1	1614.60
TOTAL	120	12	10	160	16	–	3230



NOTES:

AutoCAD® hatch pattern files can be downloaded from belgard.com for use in architectural drawings.

Some patterns may not necessarily reflect the percentages of stone sizes within a particular pallet. In some cases you may have extras in one or more of the sizes. This must be accounted for in your planning and design.

Percentages are estimated based on area by paver.

25% 6 x 12 Rectangles

25% 9 x 12 Rectangles



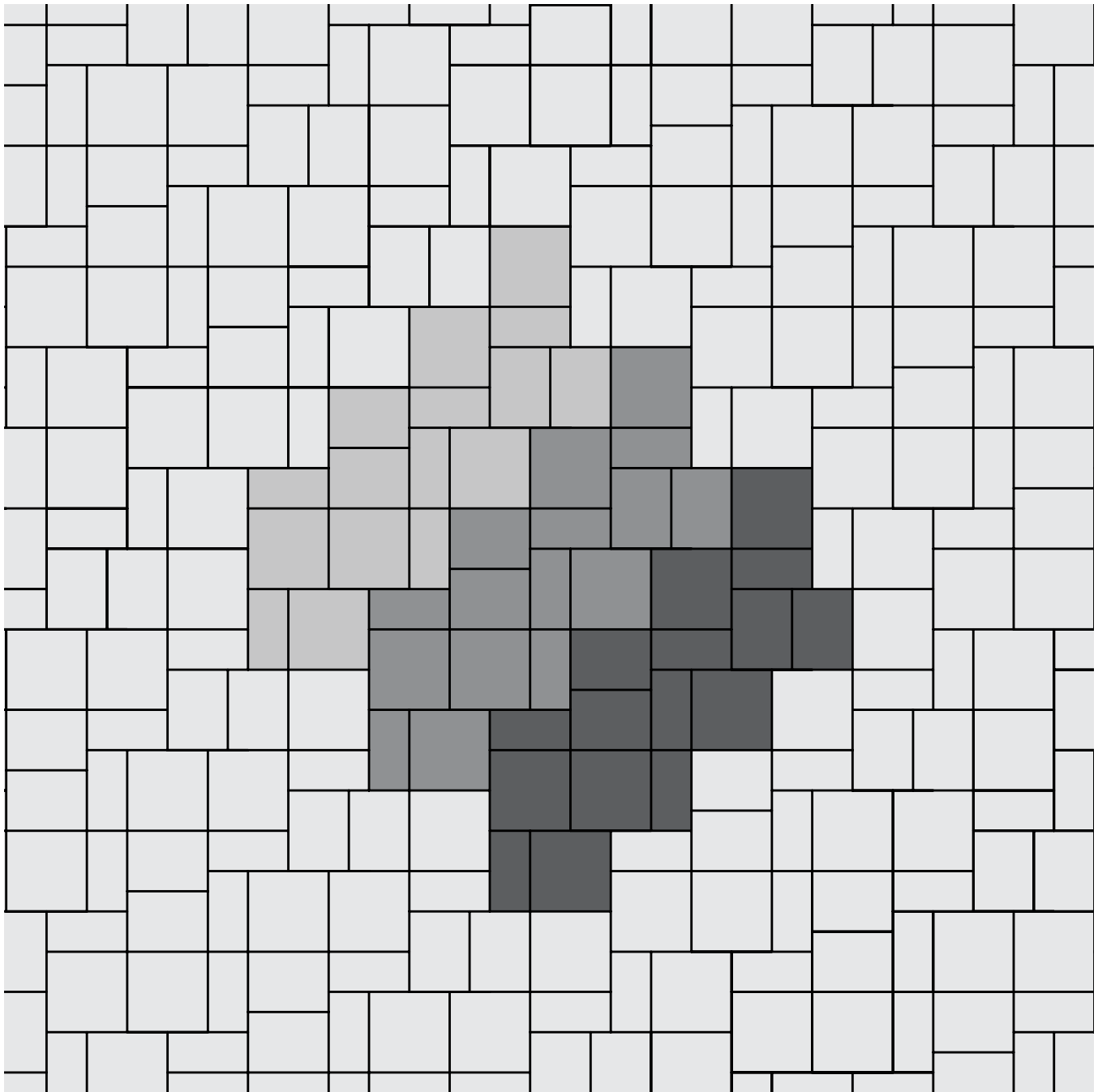



50% 12 x 12 Squares



DIMENSIONS™ 3-PIECE SYSTEM



Scan for additional
product information

PEDESTRIAN	LIGHT/REGULAR TRAFFIC	HEAVY TRAFFIC	CORE MIX	DURAFUSION PROCESS	ADA	FINISHES		
						SHOT BLAST	GROUND FACE	TUMBLED/ ANTIQUED
✓	✓*		✓	✓**	✓	✓	✓	

*Dimensions™ 6 only.

**Available only in Dimensions 12 and 18

SHAPES & SIZES

Dimensions™ 6



3 x 6 x 2³/₈

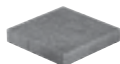

6 x 6 x 2³/₈

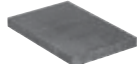

6 x 9 x 2³/₈

Dimensions™ 12



6 x 12 x 2³/₈



12 x 12 x 2³/₈



12 x 18 x 2³/₈

Dimensions™ 18



9 x 18 x 2³/₈

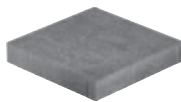

18 x 18 x 2³/₈

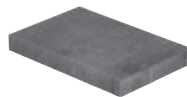

18 x 27 x 2³/₈

DIMENSIONS™ 3-PIECE SYSTEM



Scan for additional
product information

UNIT	SQFT/ PALLET	SQFT/ LAYER	LAYER/ PALLET	UNITS/ PALLET	UNITS/ LAYER	UNITS/ SQFT	WEIGHT/ PALLET
------	-----------------	----------------	------------------	------------------	-----------------	----------------	-------------------

DIMENSIONS™ 6

3 X 6 X 2 ³ / ₈	20	2	–	160	16	8	538
6 X 6 X 2 ³ / ₈	40	4	–	160	16	4	1076.4
6 X 9 X 2 ³ / ₈	60	6	–	160	16	2.67	1614.6
TOTAL	120	12	10	480	48	-	3230

DIMENSIONS™ 12

6 X 12 X 2 ³ / ₈	20	2	–	40	4	2	530
12 X 12 X 2 ³ / ₈	40	4	–	40	4	1	1060
12 X 18 X 2 ³ / ₈	60	6	–	40	4	0.66	1590
TOTAL	120	12	10	120	12	-	3180







DIMENSIONS™ 18

9 X 18 X 2 ³ / ₈	22.5	2.25	–	20	2	0.88	627.4
18 X 18 X 2 ³ / ₈	22.5	2.25	–	10	1	0.44	286
18 X 27 X 2 ³ / ₈	67.5	6.75	–	20	2	0.29	1894
TOTAL	112.5	11.25	10	50	5	-	3152

DIMENSIONS™ ACCENT



Scan for additional
product information

PEDESTRIAN	LIGHT/REGULAR TRAFFIC	HEAVY TRAFFIC	CORE MIX	DURAFUSION PROCESS	ADA	FINISHES		
						SHOT BLAST	GROUND FACE	TUMBLED/ ANTIQUED
✓	✓		✓	✓	✓	✓	✓	

SHAPES & SIZES

Accent









6 x 9 x 2³/₈

UNIT	SQFT/ PALLET	SQFT/ LAYER	LAYER/ PALLET	UNITS/ PALLET	UNITS/ LAYER	UNITS/ SQFT	WEIGHT/ PALLET
ACCENT							
6 X 9 X 2³/₈	112	11.2	10	300	30	2.67	3020

DIMENSIONS™ PLANK



Scan for additional
product information

PEDESTRIAN	LIGHT/REGULAR TRAFFIC	HEAVY TRAFFIC	CORE MIX	DURAFUSION PROCESS	ADA
					
✓	✓		✓	✓	✓

SHAPES & SIZES

3 x 9 | 80mm

3 x 12 | 80mm



3 x 9 x 3 1/8

3 x 12 x 3 1/8

(only available
in DuraFusion)

UNIT	SQFT/ PALLET	SQFT/ LAYER	LAYER/ PALLET	UNITS/ PALLET	UNITS/ LAYER	UNITS/ SQFT	WEIGHT/ PALLET
3 X 9 PLANK 80MM							
3 X 9 X 3 1/8	87	10.85	8	480	48	5.33	3132
3 X 12 PLANK 80MM							
3 X 12 X 3 1/8	88	11	8	352	44	4	3300



MIX PATTERN

NOTES:

AutoCAD® hatch pattern files can be downloaded from belgard.com for use in architectural drawings.

Some patterns may not necessarily reflect the percentages of stone sizes within a particular pallet. In some cases you may have extras in one or more of the sizes. This must be accounted for in your planning and design.

Percentages are estimated based on area by paver.

*Percentage of surface area (sq. ft)

MIX PATTERN

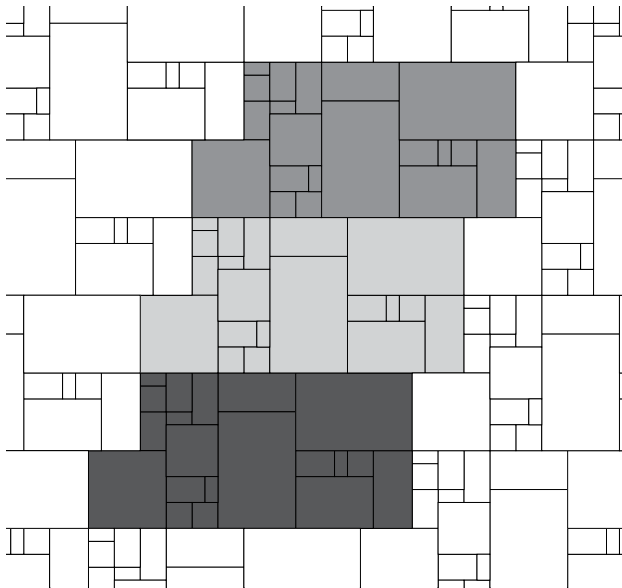

Dimensions 6 - 30% | Dimensions 12 - 15%* | Dimensions 18 - 55%**

MIX PATTERN

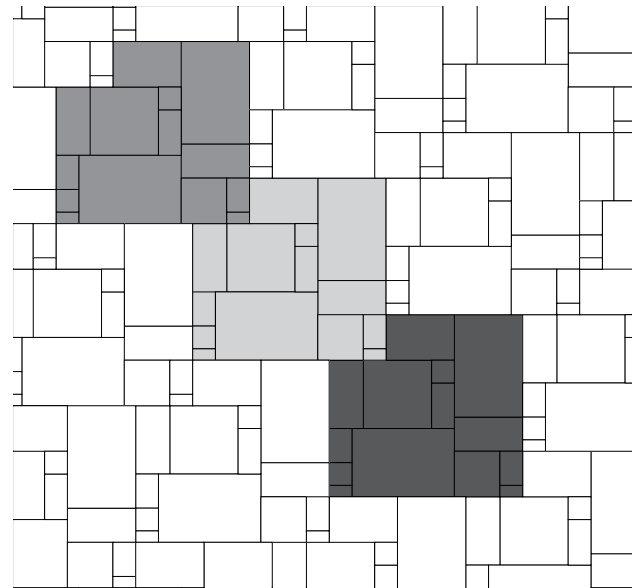

Dimensions 6 - 17.5% | Dimensions 12 - 17.5%* | Dimensions 18 - 65%**

NOTES:

AutoCAD® hatch pattern files can be downloaded from belgard.com for use in architectural drawings.

Some patterns may not necessarily reflect the percentages of stone sizes within a particular pallet. In some cases you may have extras in one or more of the sizes. This must be accounted for in your planning and design.

Percentages are estimated based on area by paver.



MIX PATTERN

*Percentage of surface area (sq. ft)

MIX PATTERN

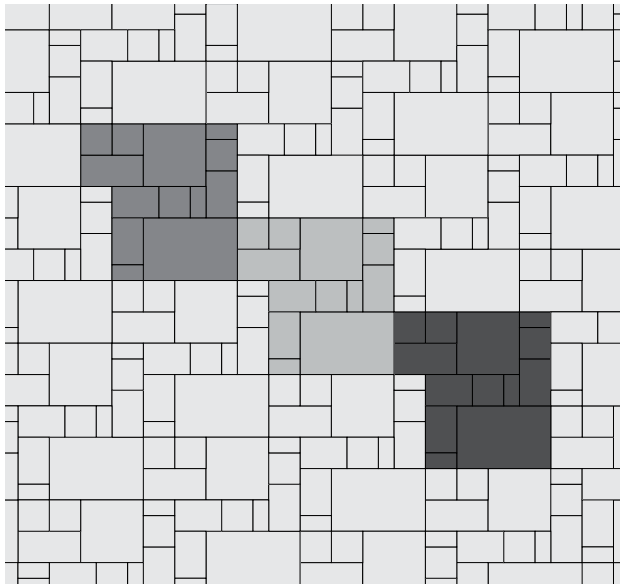

Dimensions 6 - 66.6% | Dimensions 12 - 33.3%**

MIX PATTERN

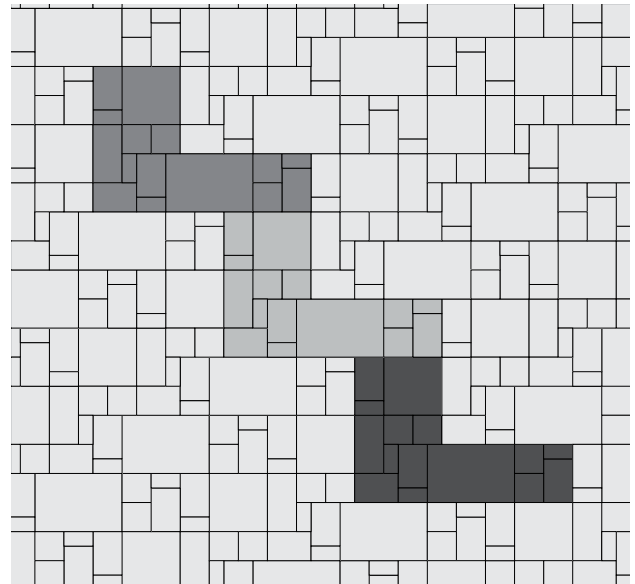

Dimensions 6 - 66.6% | Dimensions 12 - 33.3%**

MIX PATTERN

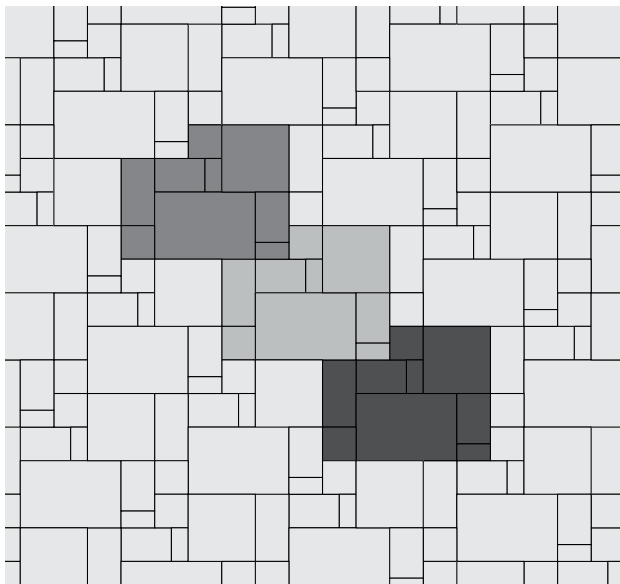

Dimensions 6 - 50% | Dimensions 12 - 50%**



NOTES:

AutoCAD® hatch pattern files can be downloaded from belgard.com for use in architectural drawings.

Some patterns may not necessarily reflect the percentages of stone sizes within a particular pallet. In some cases you may have extras in one or more of the sizes. This must be accounted for in your planning and design.

Percentages are estimated based on area by paver.

Dimensions 6 - 35%*

Dimensions 18 - 65%*

*Percentage of surface area (sq. ft)

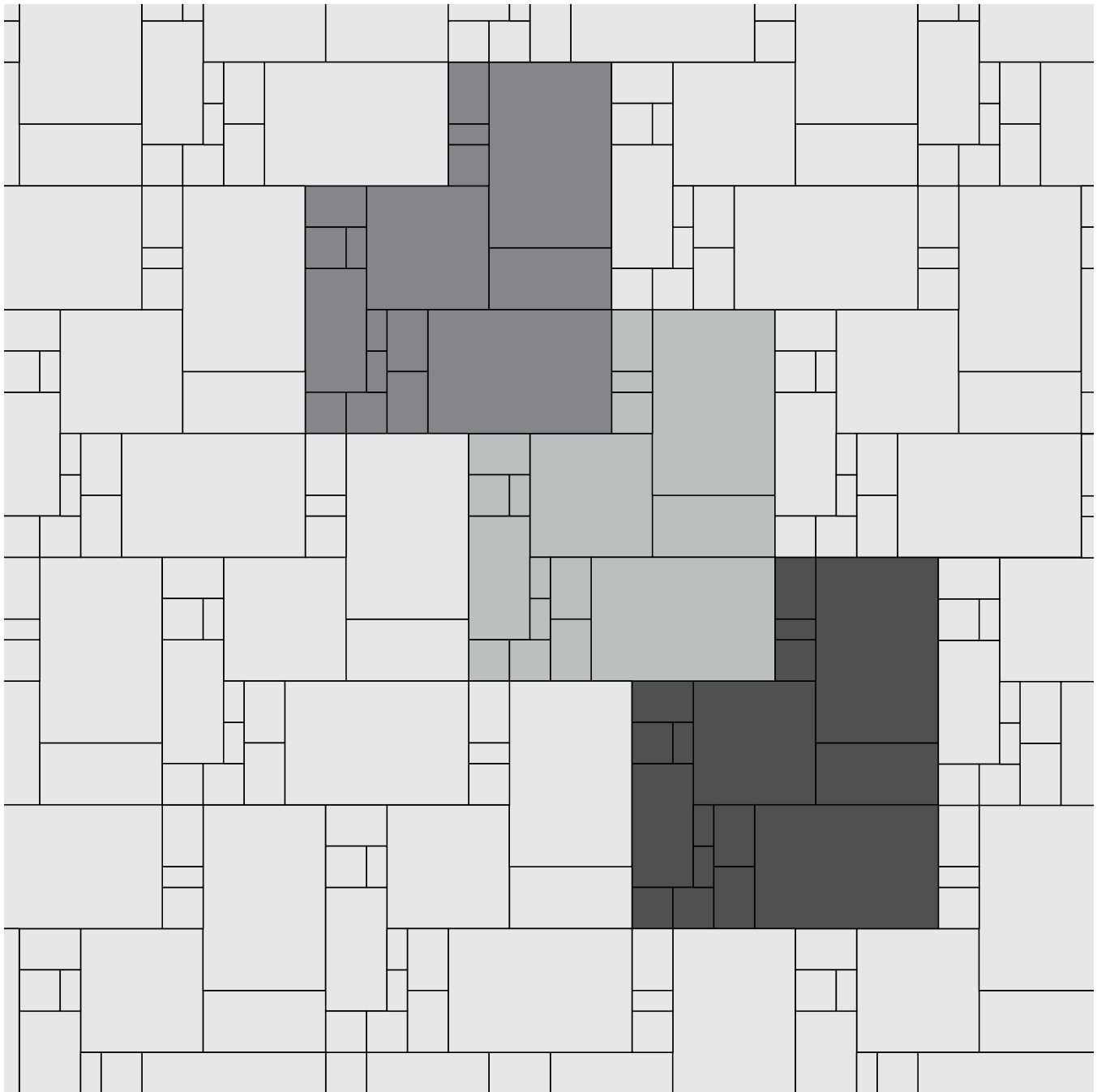



NOTES:

AutoCAD® hatch pattern files can be downloaded from belgard.com for use in architectural drawings.

Some patterns may not necessarily reflect the percentages of stone sizes within a particular pallet. In some cases you may have extras in one or more of the sizes. This must be accounted for in your planning and design.

Percentages are estimated based on area by paver.

Dimensions 12 - 52%*

Dimensions 18 - 48%*

*Percentage of surface area (sq. ft)

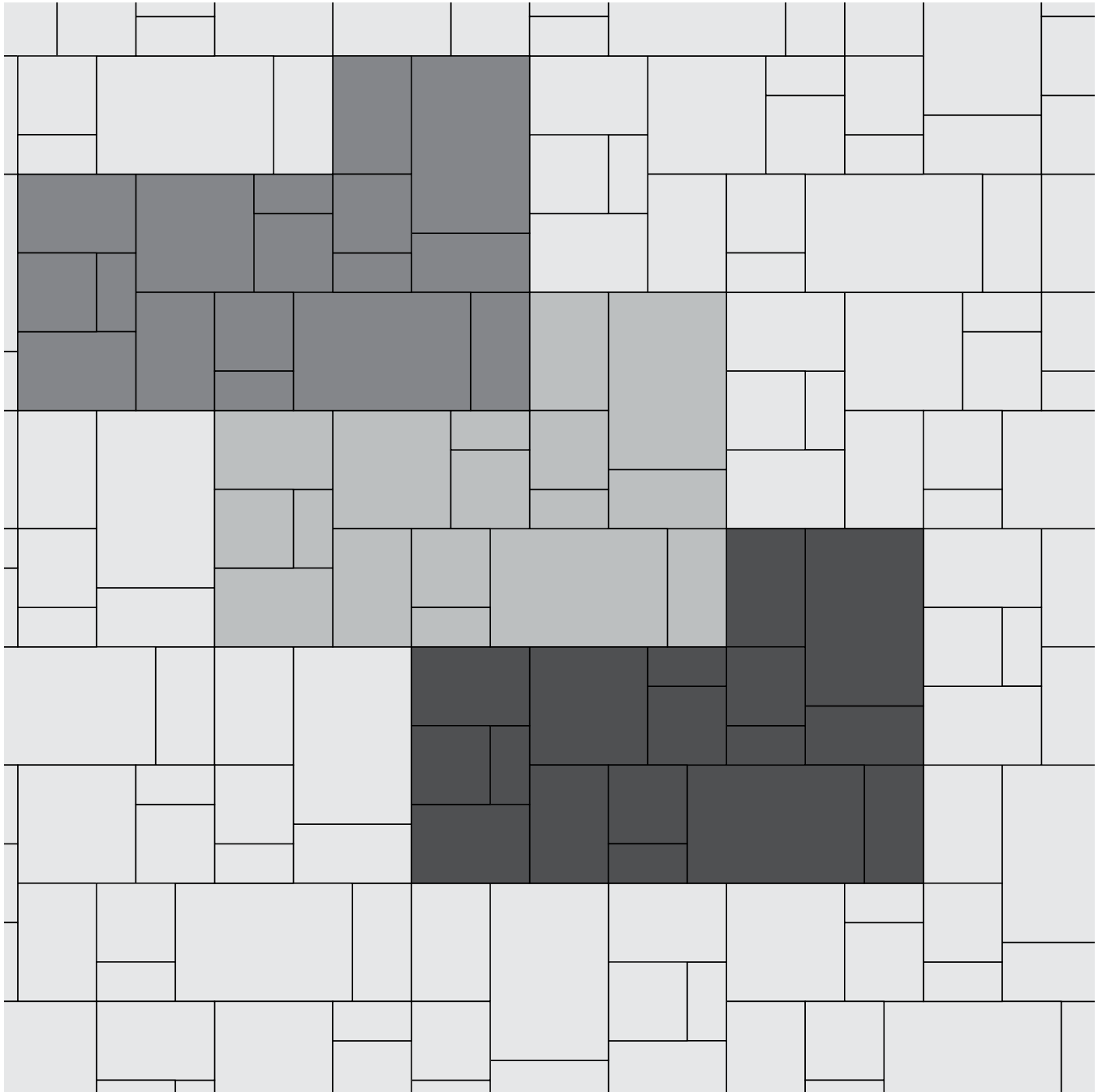



MIX PATTERN

NOTES:

AutoCAD® hatch pattern files can be downloaded from belgard.com for use in architectural drawings.

Some patterns may not necessarily reflect the percentages of stone sizes within a particular pallet. In some cases you may have extras in one or more of the sizes. This must be accounted for in your planning and design.

Percentages are estimated based on area by paver.

*Percentage of surface area (sq. ft)

MIX PATTERN

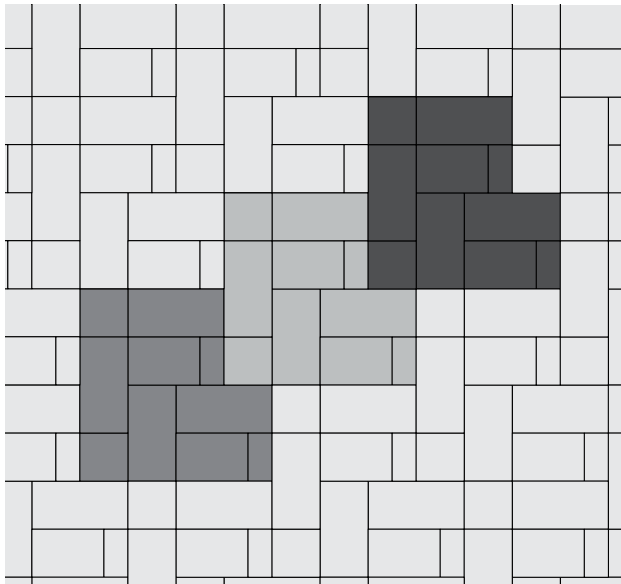

Dimensions 12 x 24 - 57% | Dimensions 12 - 43%**

MIX PATTERN

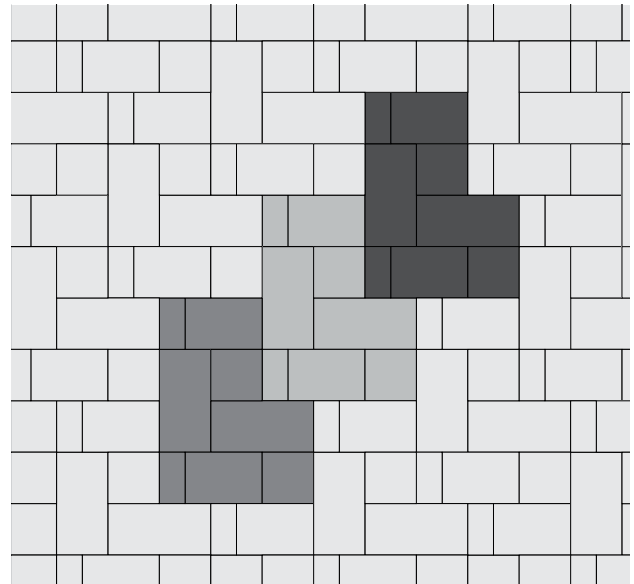

Dimensions 12 x 24 - 40% | Dimensions 12 - 60%**



MIX PATTERN

NOTES:

AutoCAD® hatch pattern files can be downloaded from belgard.com for use in architectural drawings.

Some patterns may not necessarily reflect the percentages of stone sizes within a particular pallet. In some cases you may have extras in one or more of the sizes. This must be accounted for in your planning and design.

Percentages are estimated based on area by paver.

*Percentage of surface area (sq. ft)

MIX PATTERN

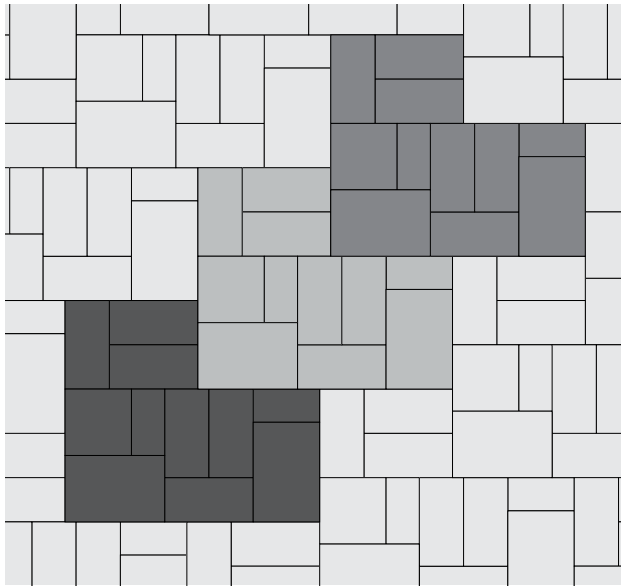

Dimensions 12 x 24 - 52% | Dimensions 18 - 48%**

MIX PATTERN

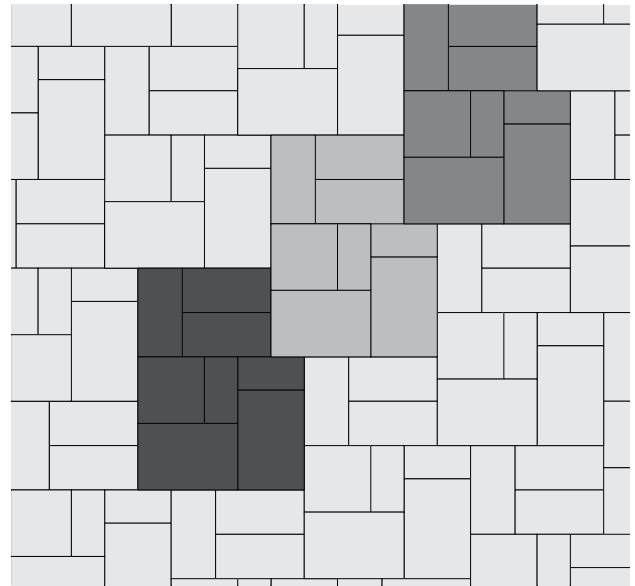







Dimensions 12 x 24 - 35% | Dimensions 18 - 65%**

DIMENSIONS™ SLAB



Scan for additional
product information

**Special Order Only
Contact your local Belgard representative for more information.*

PEDESTRIAN	LIGHT/REGULAR TRAFFIC	HEAVY TRAFFIC	CORE MIX	DURAFUSION PROCESS	ADA	FINISHES		
						SHOT BLAST	GROUND FACE	TUMBLED/ ANTIQUED
✓			✓	✓	✓	✓**	✓*	

SHAPES & SIZES

12 x 24

24 x 24

24 x 36 (only available in DuraFusion)

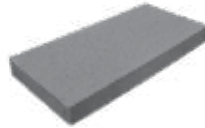
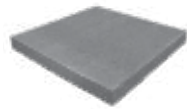

12 x 24 x 2³/₈

24 x 24 x 2³/₈

24 x 36 x 2³/₈

NOTE: For paving slab applications, some contractors prefer to pre-compact screeded bedding sand with a small plate compactor. If pre-compaction is done, care must be taken to leave no indentations in the bedding sand surface from the plate compactor. These can be removed by screeding the surface to create a thin layer (6 – 10mm) of uncompacted sand (also known as fluffing). Paving slabs do not interlock and therefore do not spread loads to their neighbors via joint sand. Given this condition, there is no requirement to force bedding sand into the bottom of the joints when compacting the units on uncompacted bedding sand, as is done with interlocking concrete pavers. Compacting large slab units could lead to unnecessary breakage, so many times contractors may choose to use a mallet or roller compactor to tamp the slabs into place once laid. Slabs do not meet the standard compressive and flexural strengths of interlocking concrete pavers, therefore, **Belgard will not be responsible for breakage to Dimensions Slabs caused by compaction.**

**Dimensions™ 6 only.*

DIMENSIONS™ SLAB

UNIT	SQFT/ PALLET	SQFT/ LAYER	LAYER/ PALLET	UNITS/ PALLET	UNITS/ LAYER	UNITS/ SQFT	WEIGHT/ PALLET
12 X 24							
12 X 24 X 2³/₈	120	12	10	60	6	0.5	3230
24 X 24							
24 X 24 X 2³/₈	80	8	10	20	2	0.25	2170
24 X 36							
24 X 36 X 2³/₈	120	12	10	20	2	0.16	3240



2-PIECE PATTERN

NOTES:

AutoCAD® hatch pattern files can be downloaded from belgard.com for use in architectural drawings.

Some patterns may not necessarily reflect the percentages of stone sizes within a particular pallet. In some cases you may have extras in one or more of the sizes. This must be accounted for in your planning and design.

Percentages are estimated based on area by paver.





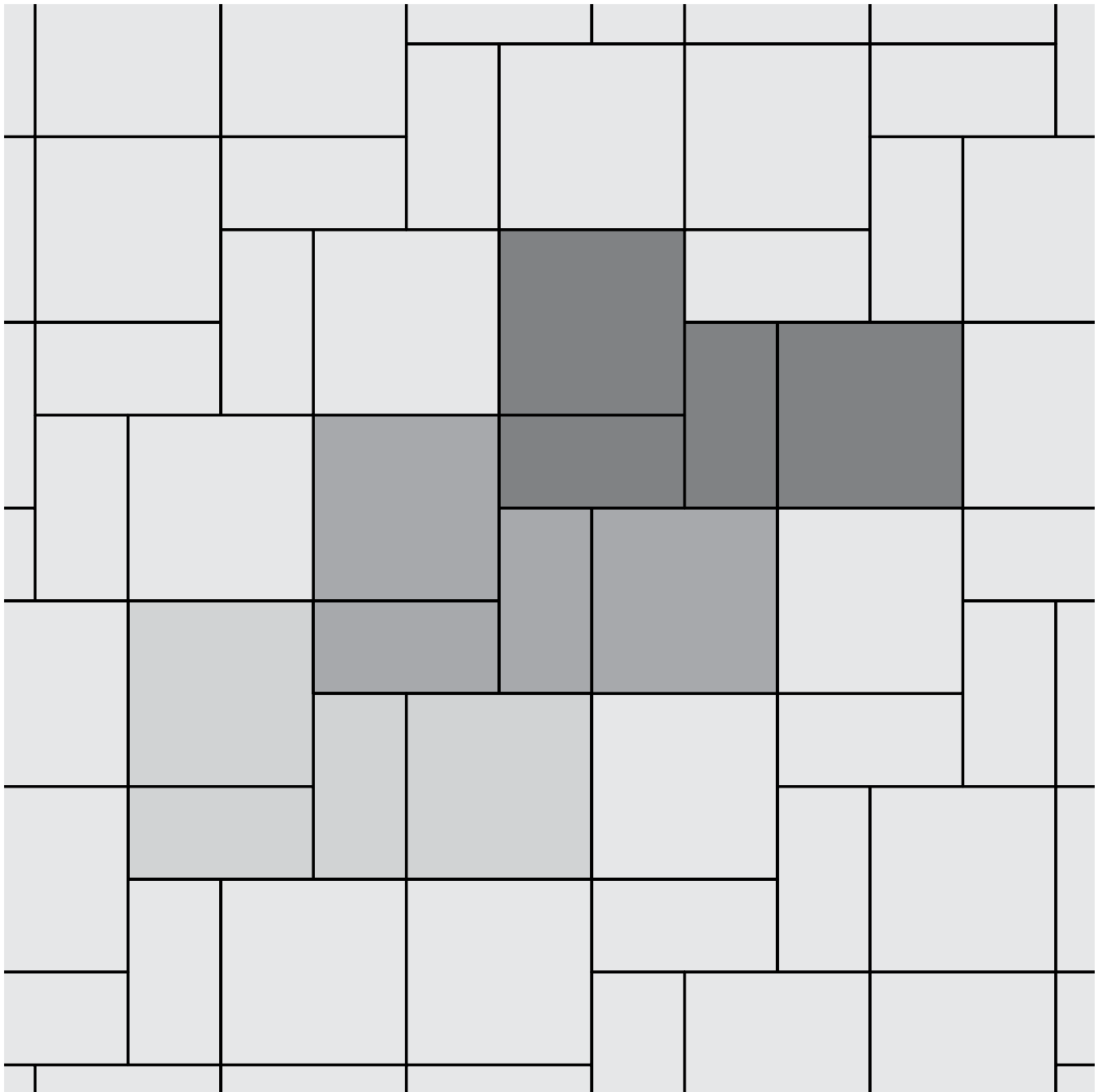

33% 12 x 24 Rectangles

67% 24 x 24 Squares





Scan for additional
product information

PEDESTRIAN	LIGHT/REGULAR TRAFFIC	HEAVY TRAFFIC	CORE MIX	DURAFUSION PROCESS	ADA
					
✓			✓	✓	✓

SHAPES & SIZES

3-Piece Modular

Large Square



3 x 6 x 2³/₈

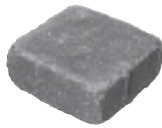

6 x 6 x 2³/₈



6 x 9 x 2³/₈

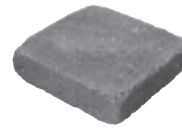

9 x 9 x 2³/₈

UNIT	SQFT/ PALLET	SQFT/ LAYER	LAYER/ PALLET	UNITS/ PALLET	UNITS/ LAYER	UNITS/ SQFT	WEIGHT/ PALLET
------	-----------------	----------------	------------------	------------------	-----------------	----------------	-------------------

3-PIECE MODULAR

3 X 6 X 2 ³ / ₈	19	1.9	–	169	16	8	513.33
6 X 6 X 2 ³ / ₈	38	3.8	–	160	16	4	1026.66
6 X 9 X 2 ³ / ₈	57	5.7	–	160	16	2.67	1540
TOTAL	114	11.4	10	480	48	–	3080

LARGE SQUARE

9 X 9 X 2 ³ / ₈	106	10.6	10	200	20	1.88	2860
---------------------------------------	-----	------	----	-----	----	------	------

NOTES:

AutoCAD® hatch pattern files can be downloaded from belgard.com for use in architectural drawings.

Some patterns may not necessarily reflect the percentages of stone sizes within a particular pallet. In some cases you may have extras in one or more of the sizes. This must be accounted for in your planning and design.

Percentages are estimated based on area by paver.

17% 3 x 6 Rectangles

33% 6 x 6 Squares

50% 6 x 9 Rectangles

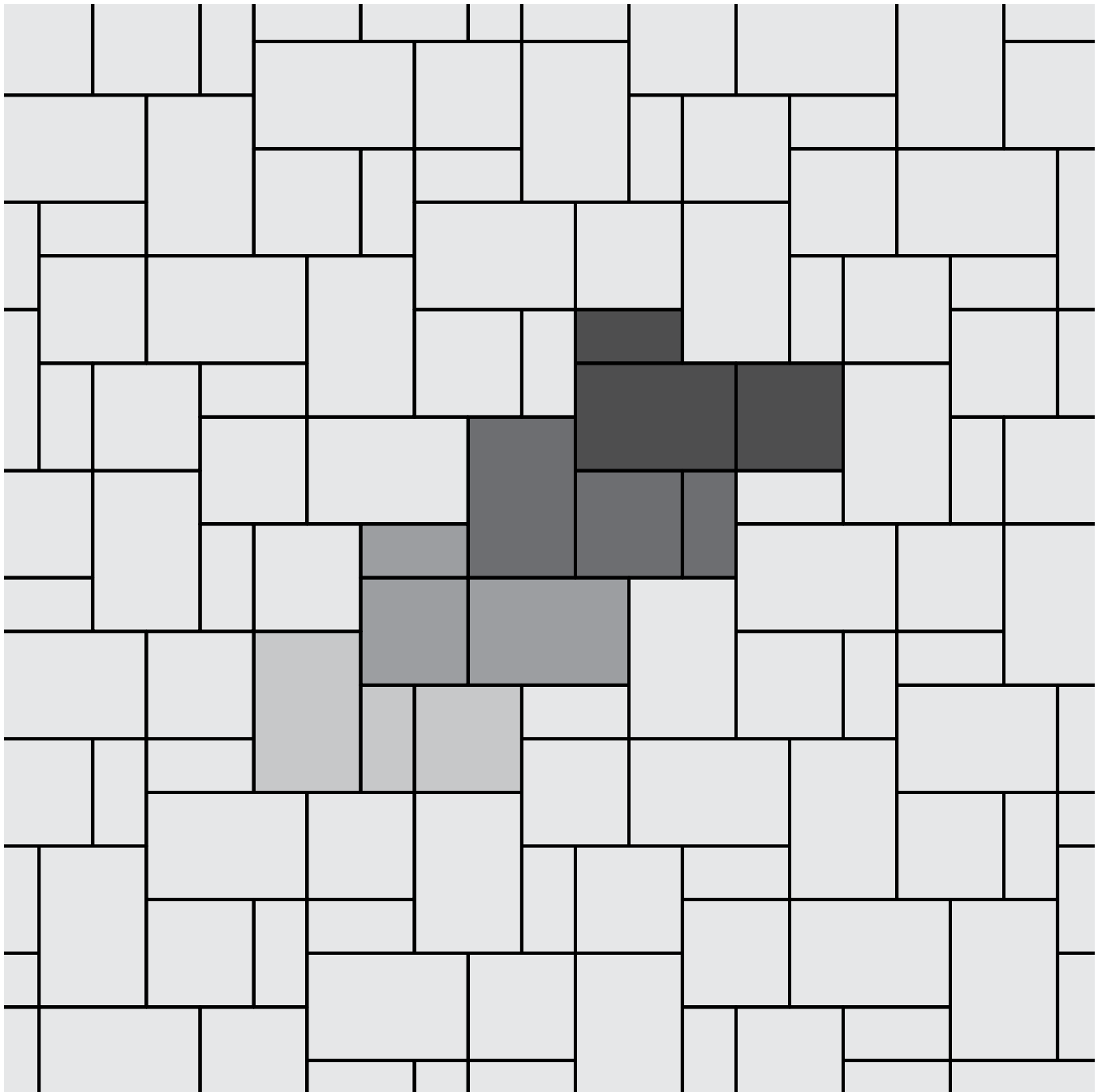



NOTES:

AutoCAD® hatch pattern files can be downloaded from belgard.com for use in architectural drawings.

Some patterns may not necessarily reflect the percentages of stone sizes within a particular pallet. In some cases you may have extras in one or more of the sizes. This must be accounted for in your planning and design.

Percentages are estimated based on area by paver.

57% 3-Piece

43% Large Square

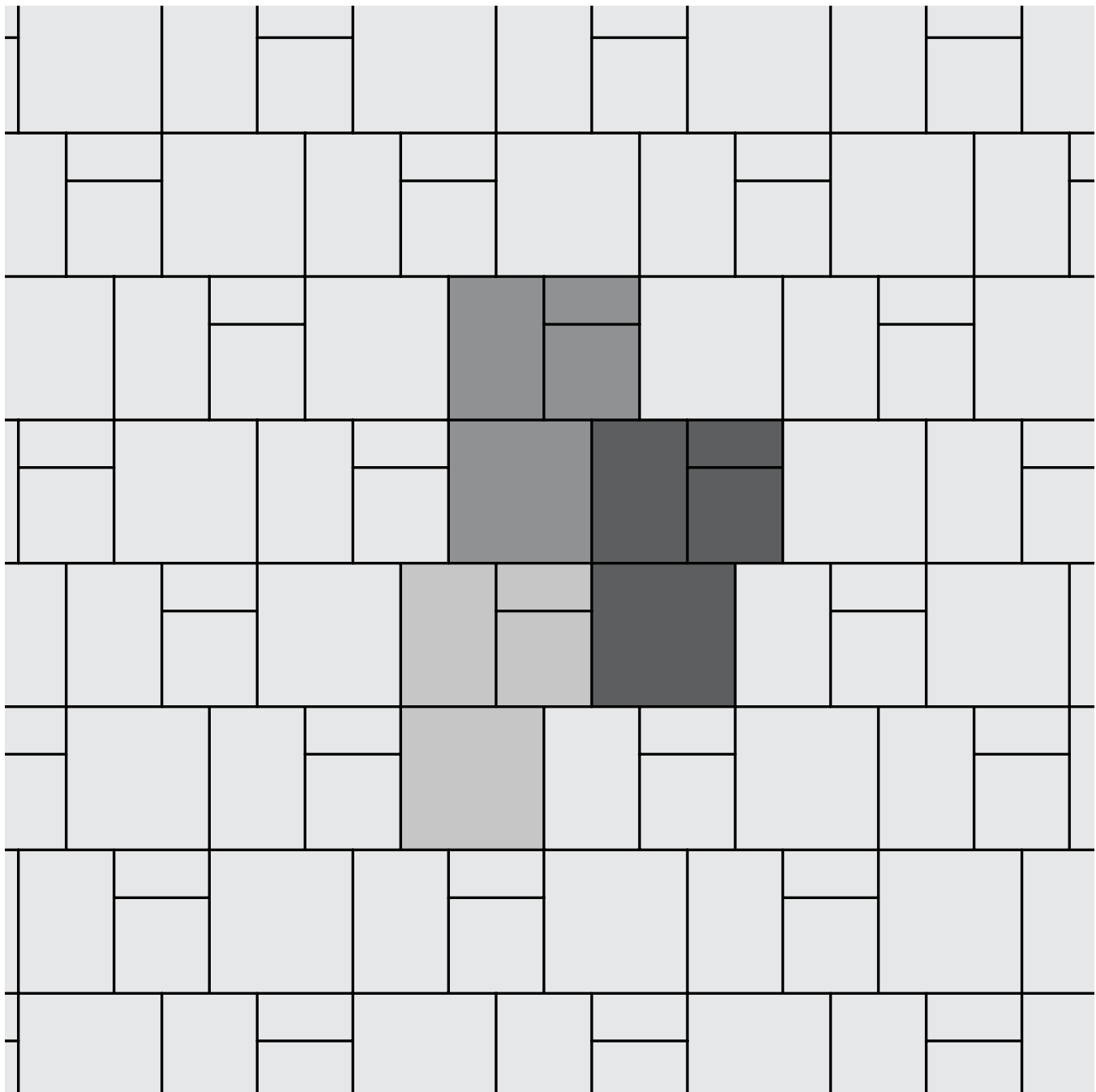



Scan for additional
product information

PEDESTRIAN	LIGHT/REGULAR TRAFFIC	HEAVY TRAFFIC	CORE MIX	DURAFUSION PROCESS	ADA
✓			✓	✓	

SHAPES & SIZES

3 x 12



3 x 12 x 2³/₈

NOTE: All 7 face styles are sold on a single pallet.

UNIT	SQFT/ PALLET	SQFT/ LAYER	LAYER/ PALLET	UNITS/ PALLET	UNITS/ LAYER	UNITS/ SQFT	WEIGHT/ PALLET
60MM							
3 X 12 X 2 ³ / ₈	110	11	10	440	44	4	3085

NOTES:

AutoCAD® hatch pattern files can be downloaded from belgard.com for use in architectural drawings.

Some patterns may not necessarily reflect the percentages of stone sizes within a particular pallet. In some cases you may have extras in one or more of the sizes. This must be accounted for in your planning and design.

Percentages are based on area by paver.

100% 3 x 12

1-PIECE HERRINGBONE PATTERN

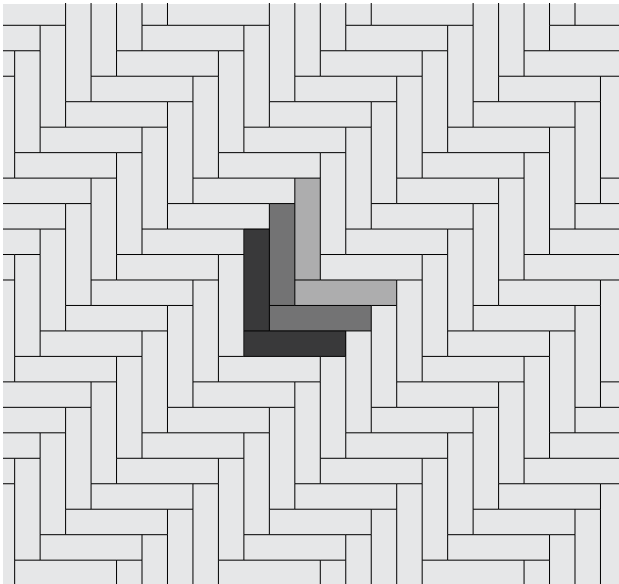

1-PIECE BASKET WEAVE PATTERN

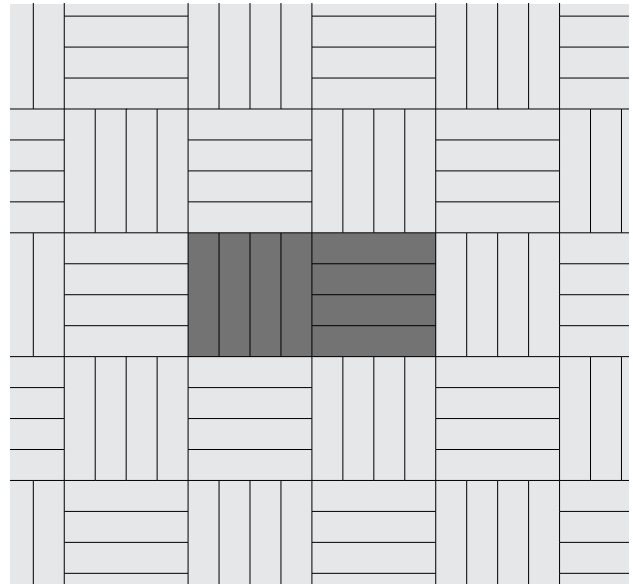



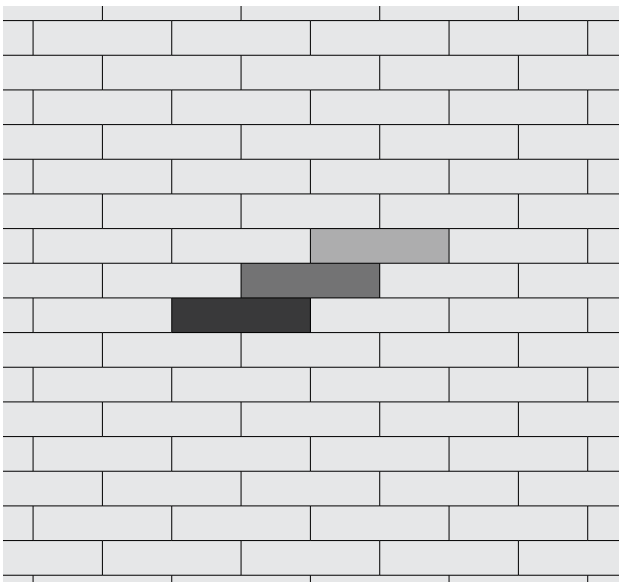



1-PIECE RUNNING BOND PATTERN





Scan for additional product information

PEDESTRIAN	LIGHT/REGULAR TRAFFIC	HEAVY TRAFFIC	CORE MIX	DURAFUSION PROCESS	ADA
					
✓	✓*		✓	✓	✓

*For Hexagon Only

SHAPES & SIZES

Hexagon



12 x 12 x 2³/₈

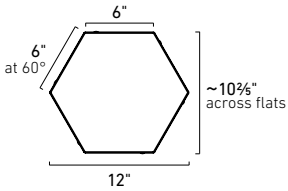

Diamond



12 x 12 x 2³/₈

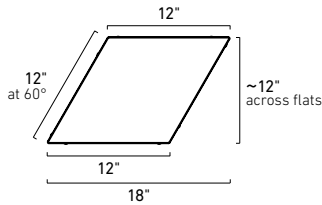

3 x 12 Parallelogram



3 x 12 x 2³/₈

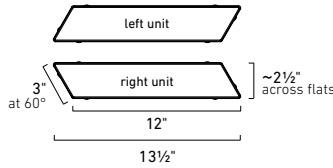

6 x 18 Parallelogram

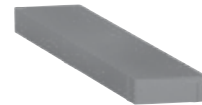

6 x 18 x 2³/₈

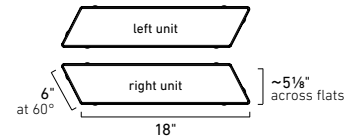

UNIT	SQFT/PALLET	SQFT/LAYER	LAYER/PALLET	UNITS/PALLET	UNITS/LAYER	UNITS/SQFT	WEIGHT/PALLET
HEXAGON							
12 X 12 X 2 ³ / ₈	100.02	9.09	11	154	14	–	2845
DIAMOND							
12 X 12 X 2 ³ / ₈	93.53	7.79	12	108	9	–	2664
3 X 12 PARALLELOGRAM							
3 X 12 X 2 ³ / ₈	85.73	7.79	11	396	36	–	2392
6 X 18 PARALLELOGRAM							
6 X 18 X 2 ³ / ₈	114.31	10.39	11	176	16	–	3225



NOTES:

AutoCAD® hatch pattern files can be downloaded from belgard.com for use in architectural drawings.

Some patterns may not necessarily reflect the percentages of stone sizes within a particular pallet. In some cases you may have extras in one or more of the sizes. This must be accounted for in your planning and design.

Percentages are estimated based on area by paver.

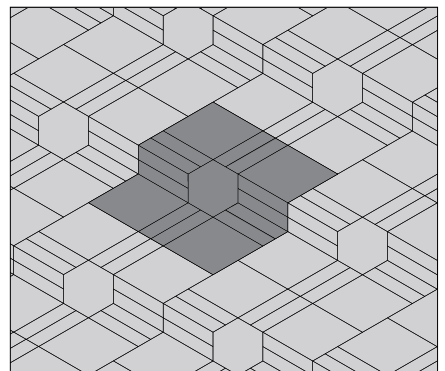
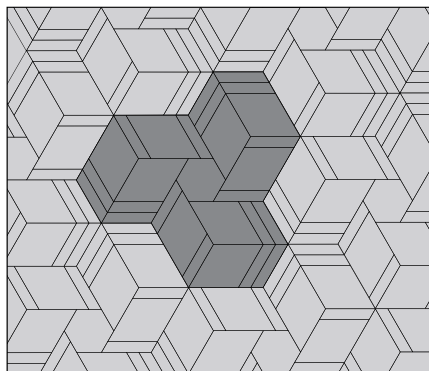
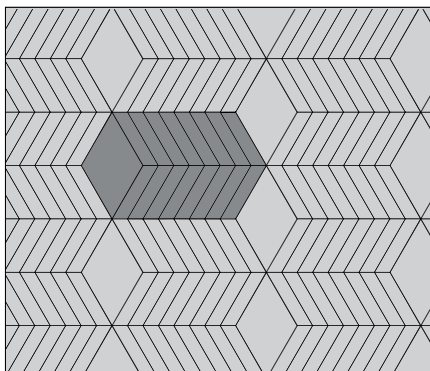
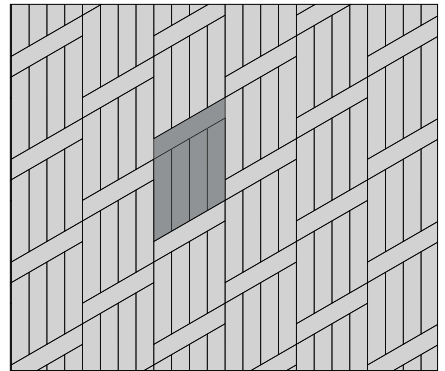
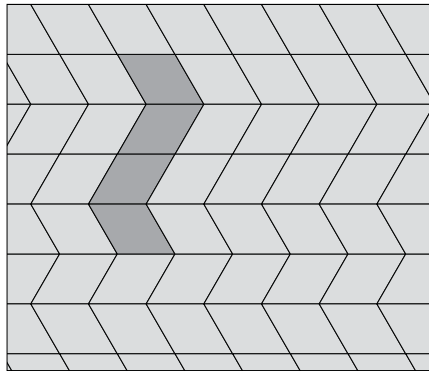
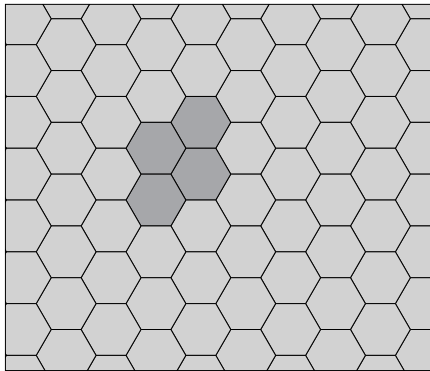









Scan for additional product information

*80MM Heavy Traffic Only
**Finishes Special Order Only

Contact your local Belgard representative for more information.

PEDESTRIAN	LIGHT/REGULAR TRAFFIC	HEAVY TRAFFIC	CORE MIX	DURAFUSION PROCESS	ADA	FINISHES		
						SHOT BLAST	GROUND FACE	TUMBLED/ANTIQUED
✓	✓	✓*	✓	✓		✓*	✓**	✓**

SHAPES & SIZES

60mm



4 x 8 x 2³/₈

80mm



4 x 8 x 3¹/₈

UNIT	SQFT/PALLET	SQFT/LAYER	LAYER/PALLET	UNITS/PALLET	UNITS/LAYER	UNITS/SQFT	WEIGHT/PALLET
60MM							
4 X 8 X 2 ³ / ₈	120	12	10	540	54	4.5	3230
80MM							
4 X 8 X 3 ¹ / ₈	96	12	8	432	54	4.5	3450

NOTES:

AutoCAD® hatch pattern files can be downloaded from belgard.com for use in architectural drawings.

Some patterns may not necessarily reflect the percentages of stone sizes within a particular pallet. In some cases you may have extras in one or more of the sizes. This must be accounted for in your planning and design.





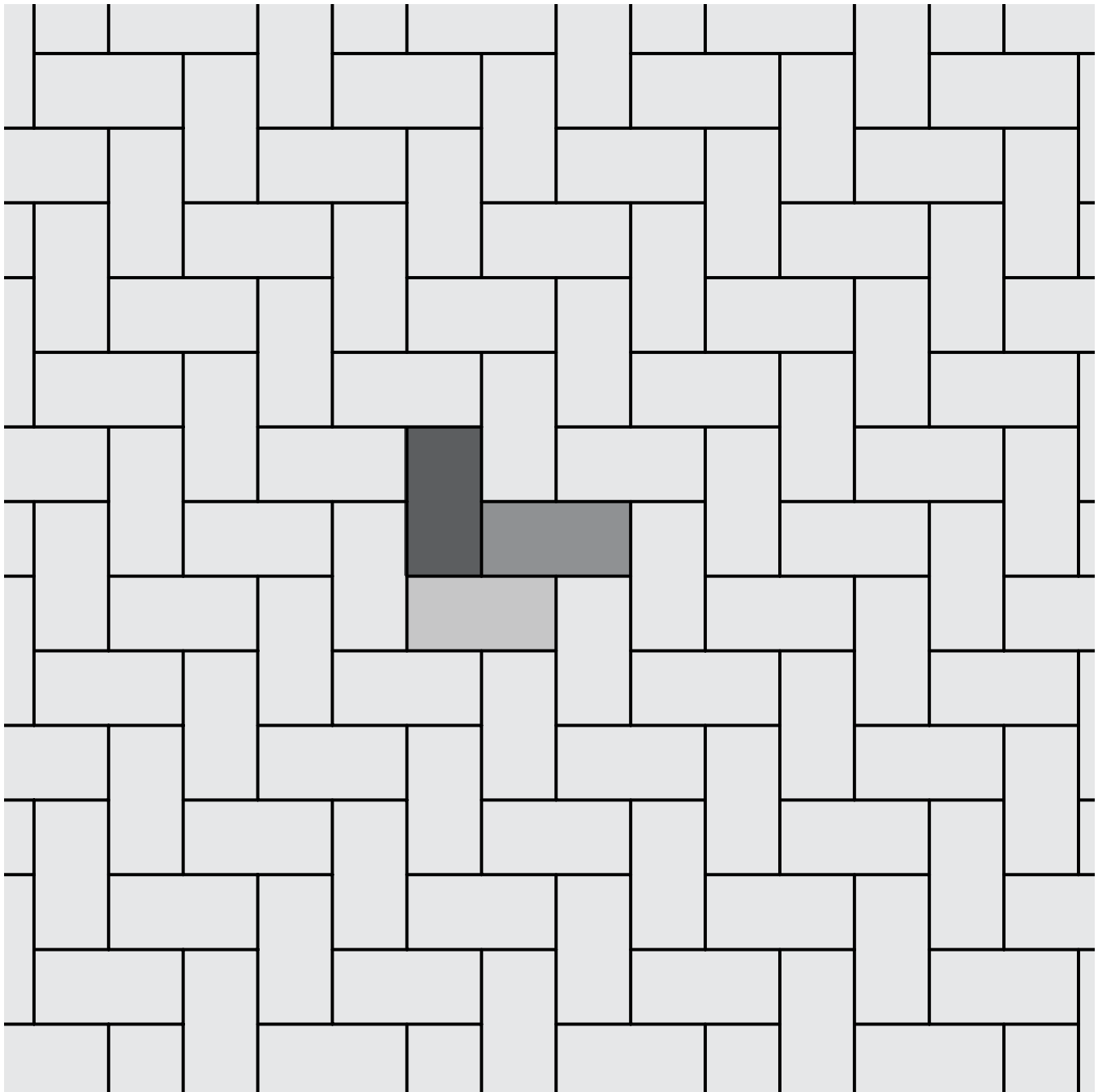

Percentages are estimated based on area by paver.

100% 60MM or 80MM Rectangles





Scan for additional
product information

PEDESTRIAN	LIGHT/REGULAR TRAFFIC	HEAVY TRAFFIC	CORE MIX	DURAFUSION PROCESS	ADA
					
✓	✓*		✓	✓	

SHAPES & SIZES

60mm



15³/₈ x 20¹/₁₆ x 2³/₈

80mm*



15³/₈ x 20¹/₁₆ x 3¹/₈

We recommend NOCO™ Polymeric Joint for this product.

*Light vehicular 80mm only, special order

UNIT	SQFT/ PALLET	SQFT/ LAYER	LAYER/ PALLET	UNITS/ PALLET	UNITS/ LAYER	UNITS/ SQFT	WEIGHT/ PALLET
60MM							
15 ³ / ₈ X 20 ¹ / ₁₆ X 2 ³ / ₈	104.4	8.7	12	72	6	0.69	2850
80MM*							
15 ³ / ₈ X 20 ¹ / ₁₆ X 3 ¹ / ₈	78.3	8.7	9	54	6	0.69	2870

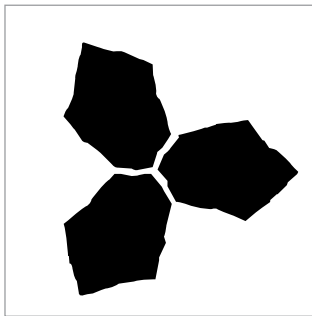

STEP 1 - Begin by laying 3 pavers at the center of the surface to be covered.

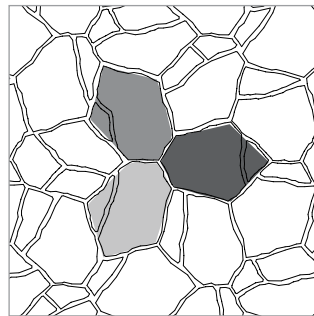

STEP 3 - Complete the balance of the surface to be covered with single pavers.

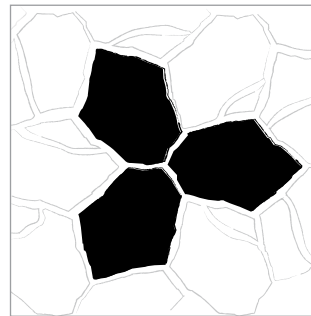

STEP 2 - Add more sets of cloverleaves to fill in the surface to be covered.

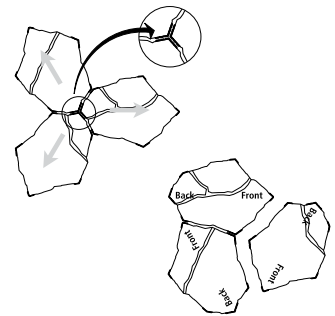

Before you start, familiarize yourself with the Mega-Arbel pavers. Begin by placing 3 pavers together to form a cloverleaf.

This is a visual of a set of 3 pavers forming a cloverleaf.

To make the installation easier, the front of the paver should point to the back of the other pavers.



NOTES:

AutoCAD® hatch pattern files can be downloaded from belgard.com for use in architectural drawings.

Some patterns may not necessarily reflect the percentages of stone sizes within a particular pallet. In some cases you may have extras in one or more of the sizes. This must be accounted for in your planning and design.

Percentages are estimated based on area by paver.

100% 15 x 20

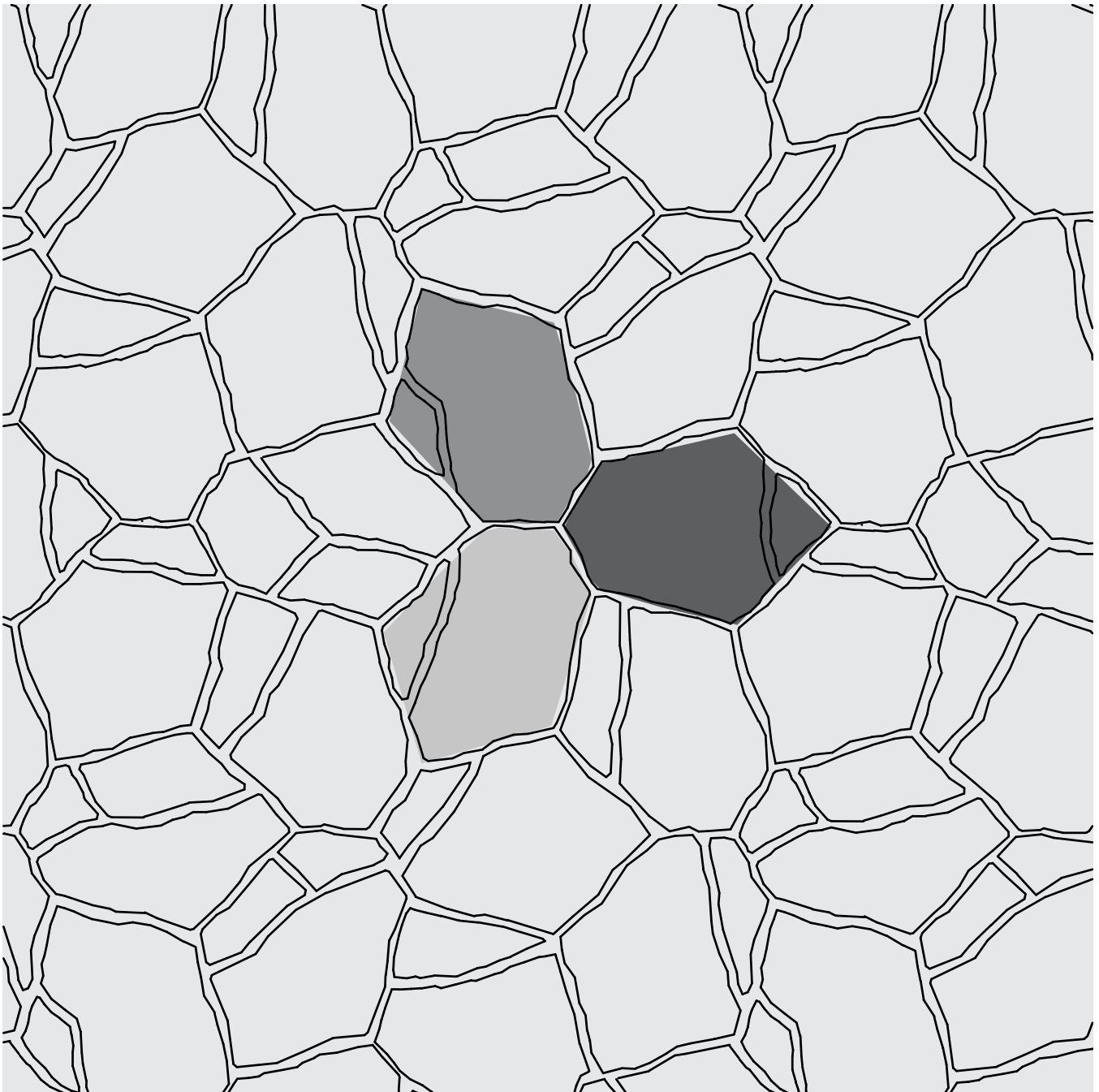







MELVILLE™ PLANK



Scan for additional product information

**Special Order Only*
Contact your local Belgard representative for more information.

PEDESTRIAN	LIGHT/REGULAR TRAFFIC	HEAVY TRAFFIC	CORE MIX	DURAFUSION PROCESS	ADA	FINISHES		
						SHOT BLAST	GROUND FACE	TUMBLED/ANTIQUED
✓	✓		✓	✓	✓	✓*	✓*	

SHAPES & SIZES

3-Piece Large

3-Piece Slim



7½ X 11¹³/₁₆ X 2³/₈

7½ X 15¾ X 2³/₈

7½ X 19¹¹/₁₆ X 2³/₈

5 X 11¹³/₁₆ X 2³/₈

5 X 15¾ X 2³/₈

5 X 19¹¹/₁₆ X 2³/₈

UNIT	SQFT/PALLET	SQFT/LAYER	LAYER/PALLET	UNITS/PALLET	UNITS/LAYER	UNITS/SQFT	WEIGHT/PALLET
------	-------------	------------	--------------	--------------	-------------	------------	---------------

3-PIECE LARGE

7½ X 11 ¹³ / ₁₆ X 2 ³ / ₈	30.35	3.035	–	50	5	1.65	845
7½ X 15¾ X 2 ³ / ₈	41	4.1	–	50	5	1.22	1149.2
7½ X 19 ¹¹ / ₁₆ X 2 ³ / ₈	51.35	5.135	–	50	5	0.97	1385.80
TOTAL	122.7	12.27	10	150	15	–	3380

3-PIECE SLIM

5 X 11 ¹³ / ₁₆ X 2 ³ / ₈	29	2.9	–	70	7	2.41	787.5
5 X 15¾ X 2 ³ / ₈	38.5	3.85	–	70	7	1.81	1071
5 X 19 ¹¹ / ₁₆ X 2 ³ / ₈	47	4.7	–	70	7	1.49	1291.5
TOTAL	114.5	11.45	10	210	21	–	3150



NOTES:

AutoCAD® hatch pattern files can be downloaded from belgard.com for use in architectural drawings.

Some patterns may not necessarily reflect the percentages of stone sizes within a particular pallet. In some cases you may have extras in one or more of the sizes. This must be accounted for in your planning and design.

Percentages are estimated based on area by paver.

25% 5 x 11 Rectangles

33% 5 x 15 Rectangles

42% 5 x 19 Rectangles

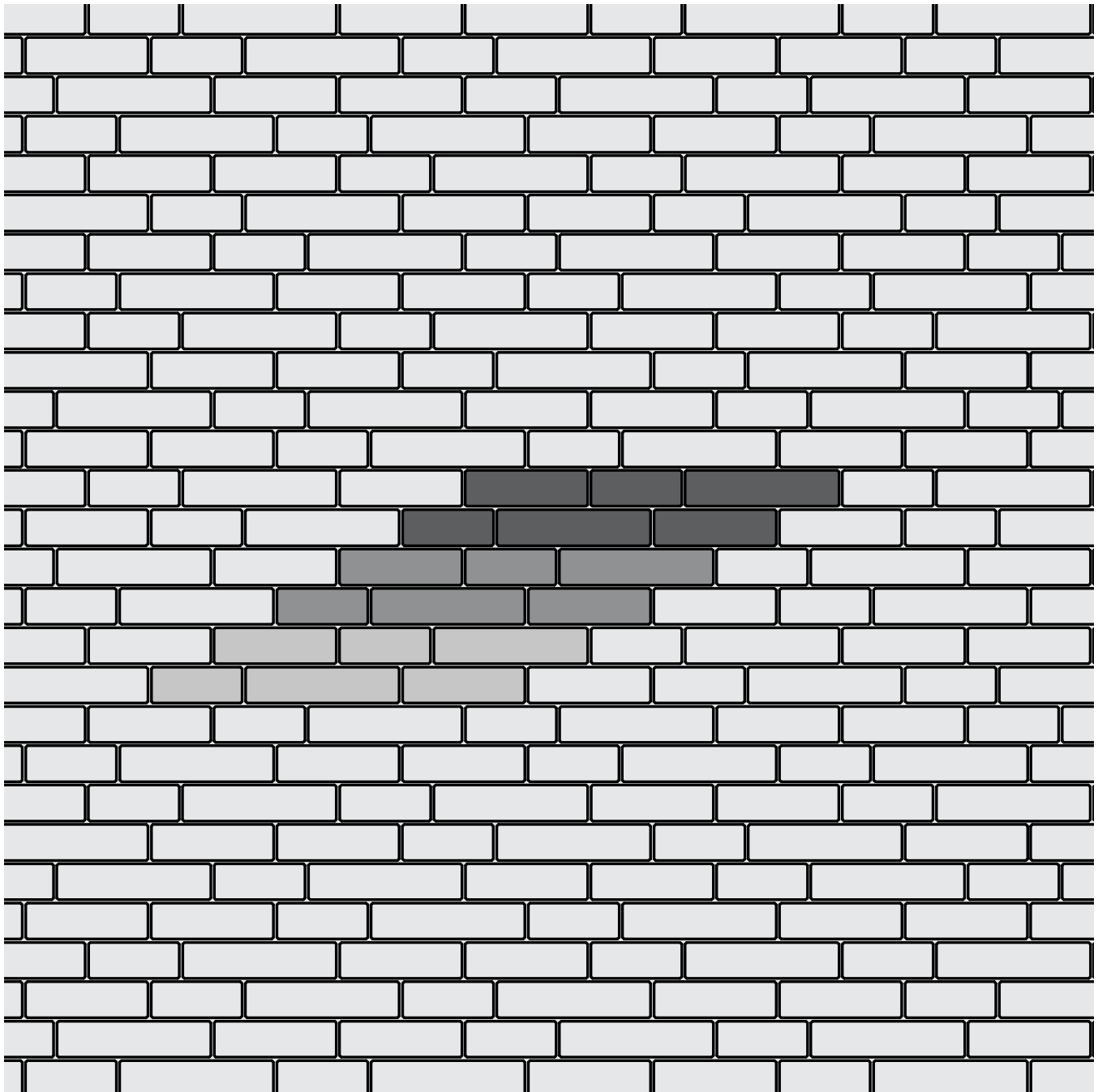



NOTES:

AutoCAD® hatch pattern files can be downloaded from belgard.com for use in architectural drawings.

Some patterns may not necessarily reflect the percentages of stone sizes within a particular pallet. In some cases you may have extras in one or more of the sizes. This must be accounted for in your planning and design.

Percentages are estimated based on area by paver.

25% 7½ x 11⅓ Rectangles

33% 7½ x 15¾ Rectangles

42% 7½ x 19⅓ Rectangles

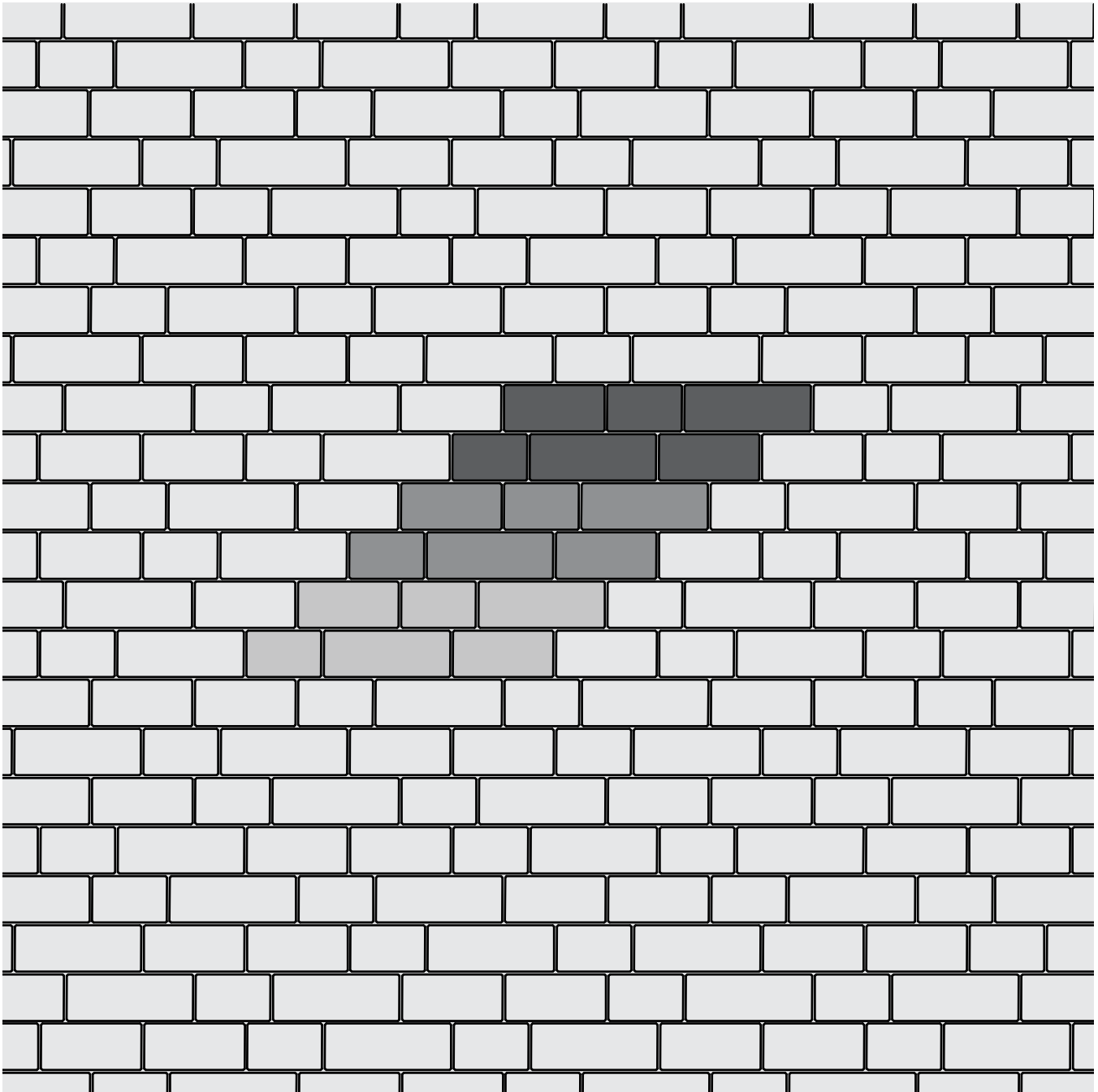



6-PIECE PATTERN

NOTES:

AutoCAD® hatch pattern files can be downloaded from belgard.com for use in architectural drawings.

Some patterns may not necessarily reflect the percentages of stone sizes within a particular pallet. In some cases you may have extras in one or more of the sizes. This must be accounted for in your planning and design.

Percentages are estimated based on area by paver.

- 40% 3-Piece Slim
- 60% 3-Piece Large

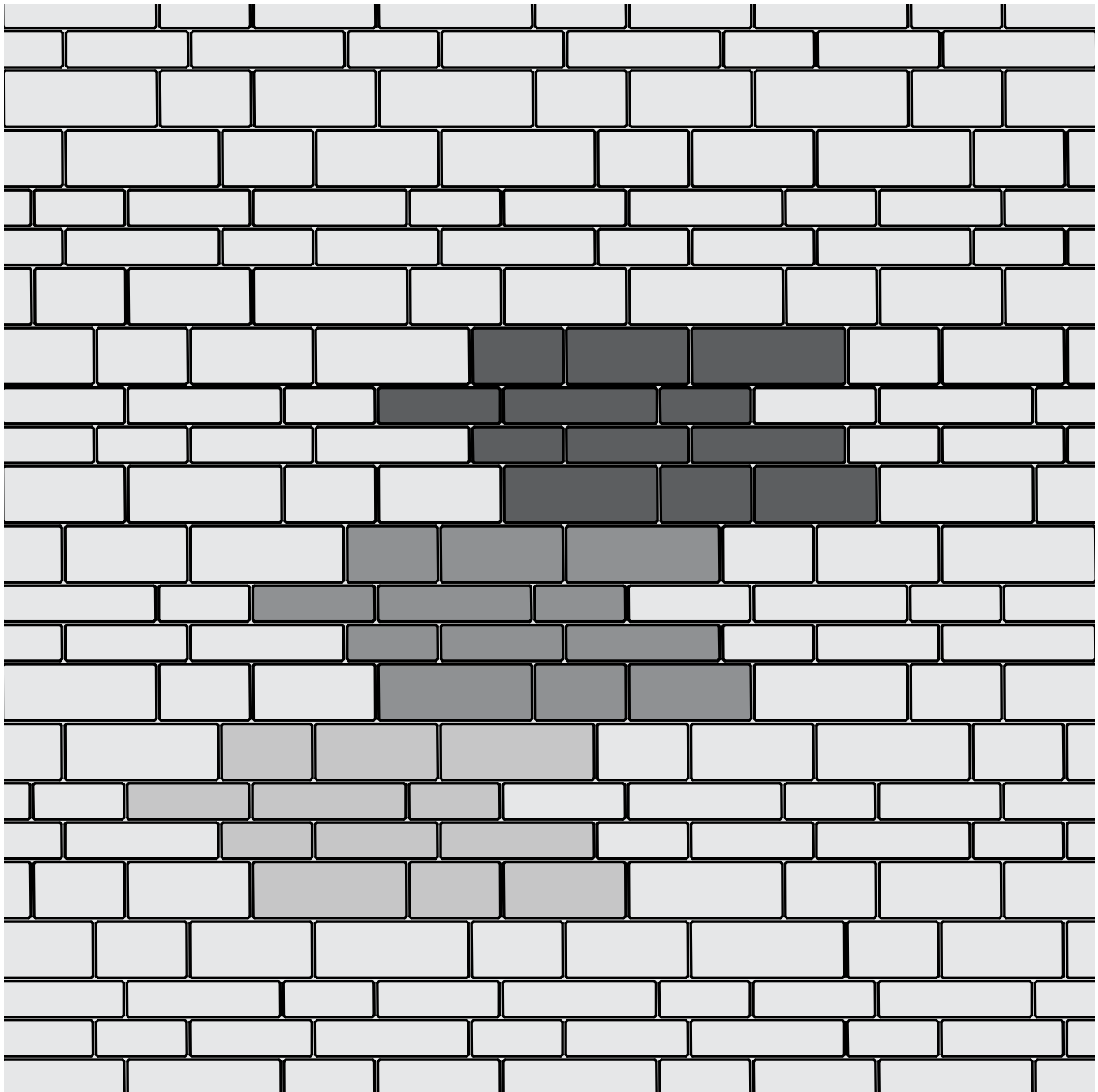







ORIGINS™ 3-PIECE SYSTEM

NATURAL
COLLECTION 



Scan for additional
product information

PEDESTRIAN	LIGHT/REGULAR TRAFFIC	HEAVY TRAFFIC	CORE MIX	DURAFUSION PROCESS	ADA
					
✓	✓*		✓	✓	✓

*Origins™ 6 only.

SHAPES & SIZES

Origins™ 6



3 x 6 x 2³/₈

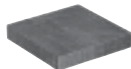

6 x 6 x 2³/₈

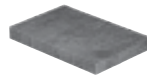

6 x 9 x 2³/₈

Origins™ 12



6 x 12 x 2³/₈

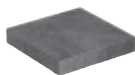

12 x 12 x 2³/₈



12 x 18 x 2³/₈

Origins™ 18



9 x 18 x 2³/₈

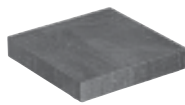

18 x 18 x 2³/₈

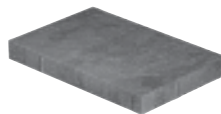

18 x 27 x 2³/₈

ORIGINS™ 3-PIECE SYSTEM

NATURAL
COLLECTION 



Scan for additional
product information

UNIT	SQFT/ PALLET	SQFT/ LAYER	LAYER/ PALLET	UNITS/ PALLET	UNITS/ LAYER	UNITS/ SQFT	WEIGHT/ PALLET
------	-----------------	----------------	------------------	------------------	-----------------	----------------	-------------------

ORIGINS™ 6

3 X 6 X 2 ³ / ₈	20	2	–	160	16	8	538
6 X 6 X 2 ³ / ₈	40	4	–	160	16	4	1076.4
6 X 9 X 2 ³ / ₈	60	6	–	160	16	2.67	1614.6
TOTAL	120	12	10	480	48	-	3230

ORIGINS™ 12







6 X 12 X 2 ³ / ₈	20	2	–	40	4	2	530
12 X 12 X 2 ³ / ₈	40	4	–	40	4	1	1060
12 X 18 X 2 ³ / ₈	60	6	–	40	4	0.66	1590
TOTAL	120	12	10	120	12	-	3180

ORIGINS™ 18

9 X 18 X 2 ³ / ₈	22.5	2.25	–	20	2	0.88	627.4
18 X 18 X 2 ³ / ₈	22.5	2.25	–	10	1	0.44	286
18 X 27 X 2 ³ / ₈	67.5	6.75	–	20	2	0.29	1894
TOTAL	112.5	11.3	10	50	5	-	3152



Scan for additional
product information

PEDESTRIAN	LIGHT/REGULAR TRAFFIC	HEAVY TRAFFIC	CORE MIX	DURAFUSION PROCESS	ADA
					
✓	✓		✓	✓	✓

SHAPES & SIZES

Accent

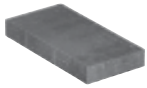

6 x 9 x 2³/₈

UNIT	SQFT/ PALLET	SQFT/ LAYER	LAYER/ PALLET	UNITS/ PALLET	UNITS/ LAYER	UNITS/ SQFT	WEIGHT/ PALLET
ACCENT							
6 X 9 X 2³/₈	112	11.2	10	300	30	2.67	3020

NOTES:

AutoCAD® hatch pattern files can be downloaded from belgard.com for use in architectural drawings.

Some patterns may not necessarily reflect the percentages of stone sizes within a particular pallet. In some cases you may have extras in one or more of the sizes. This must be accounted for in your planning and design.

Percentages are estimated based on area by paver.



MIX PATTERN

*Percentage of surface area (sq. ft)

MIX PATTERN

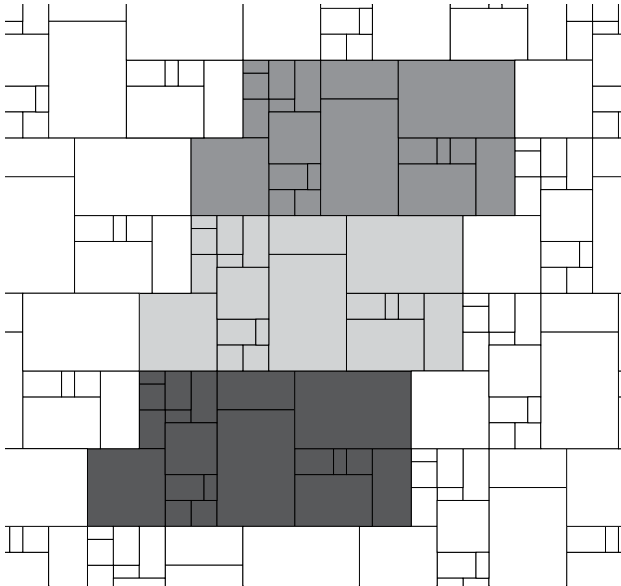

Origins 6 - 30% | Origins 12 - 15%* | Origins 18 - 55%**

MIX PATTERN

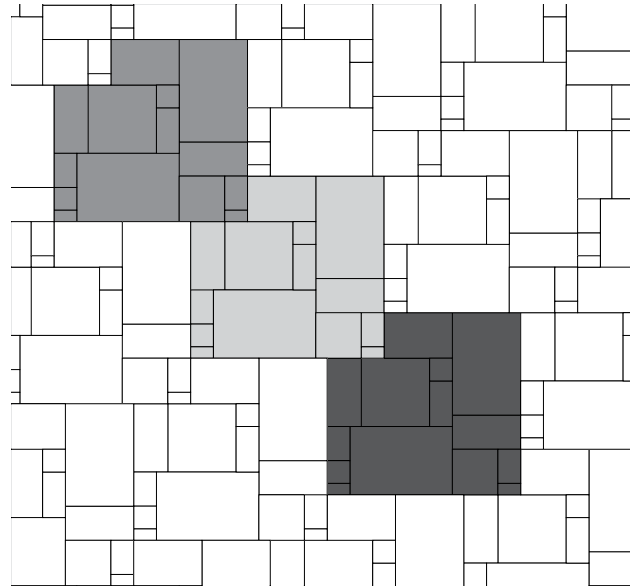

Origins 6 - 17.5% | Origins 12 - 17.5%* | Origins 18 - 65%**

NOTES:

AutoCAD® hatch pattern files can be downloaded from belgard.com for use in architectural drawings.

Some patterns may not necessarily reflect the percentages of stone sizes within a particular pallet. In some cases you may have extras in one or more of the sizes. This must be accounted for in your planning and design.

Percentages are estimated based on area by paver.



*Percentage of surface area (sq. ft)

MIX PATTERN

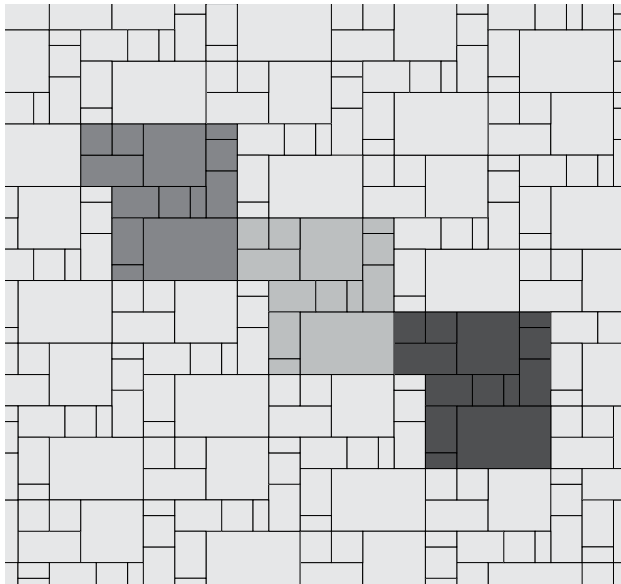

Origins 6 - 66.6% | Origins 12 - 33.3%**

MIX PATTERN

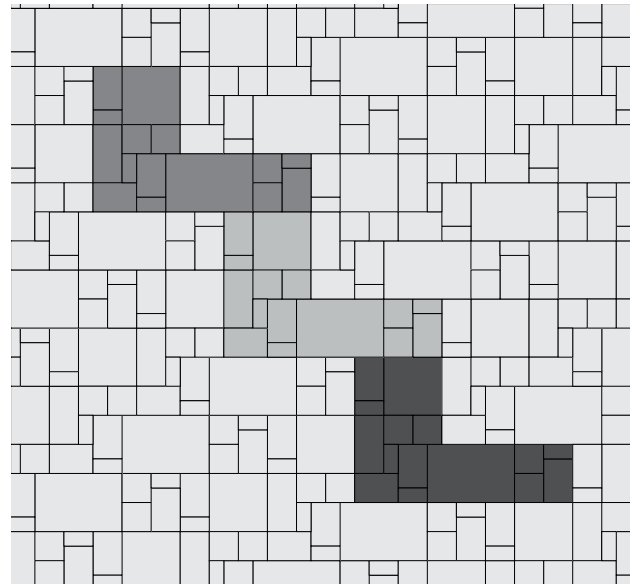

Origins 6 - 66.6% | Origins 12 - 33.3%**

MIX PATTERN

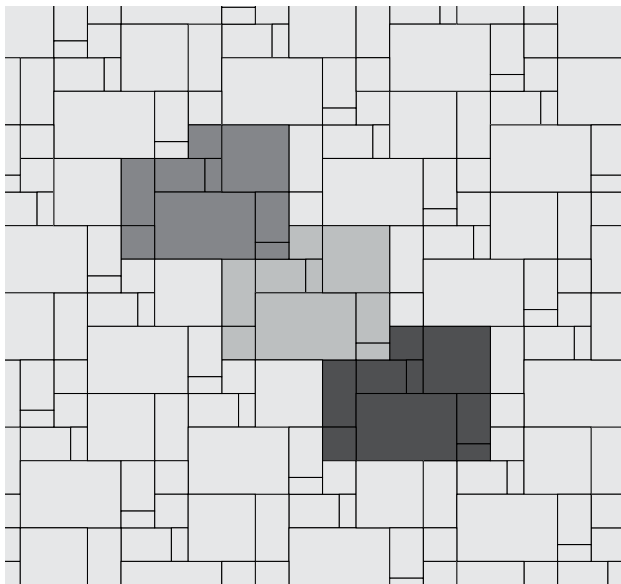

Origins 6 - 50% | Origins 12 - 50%**



NOTES:

AutoCAD® hatch pattern files can be downloaded from belgard.com for use in architectural drawings.

Some patterns may not necessarily reflect the percentages of stone sizes within a particular pallet. In some cases you may have extras in one or more of the sizes. This must be accounted for in your planning and design.

Percentages are estimated based on area by paver.

Origins 6 - 35%*

Origins 18 - 65%*

*Percentage of surface area (sq. ft)

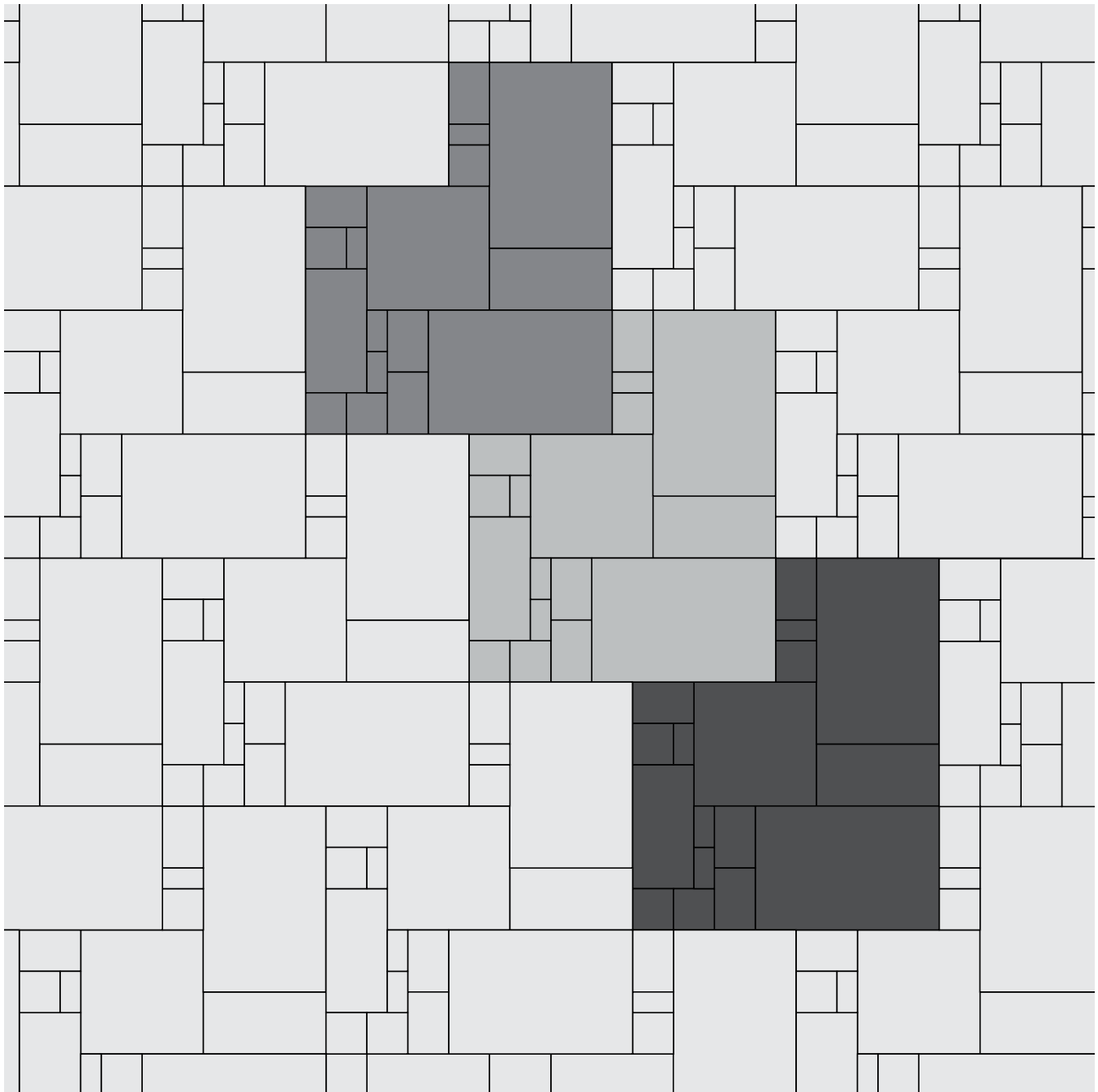



NOTES:

AutoCAD® hatch pattern files can be downloaded from belgard.com for use in architectural drawings.

Some patterns may not necessarily reflect the percentages of stone sizes within a particular pallet. In some cases you may have extras in one or more of the sizes. This must be accounted for in your planning and design.

Percentages are estimated based on area by paver.

Origins 12 - 52%*

Origins 18 - 48%*

*Percentage of surface area (sq. ft)

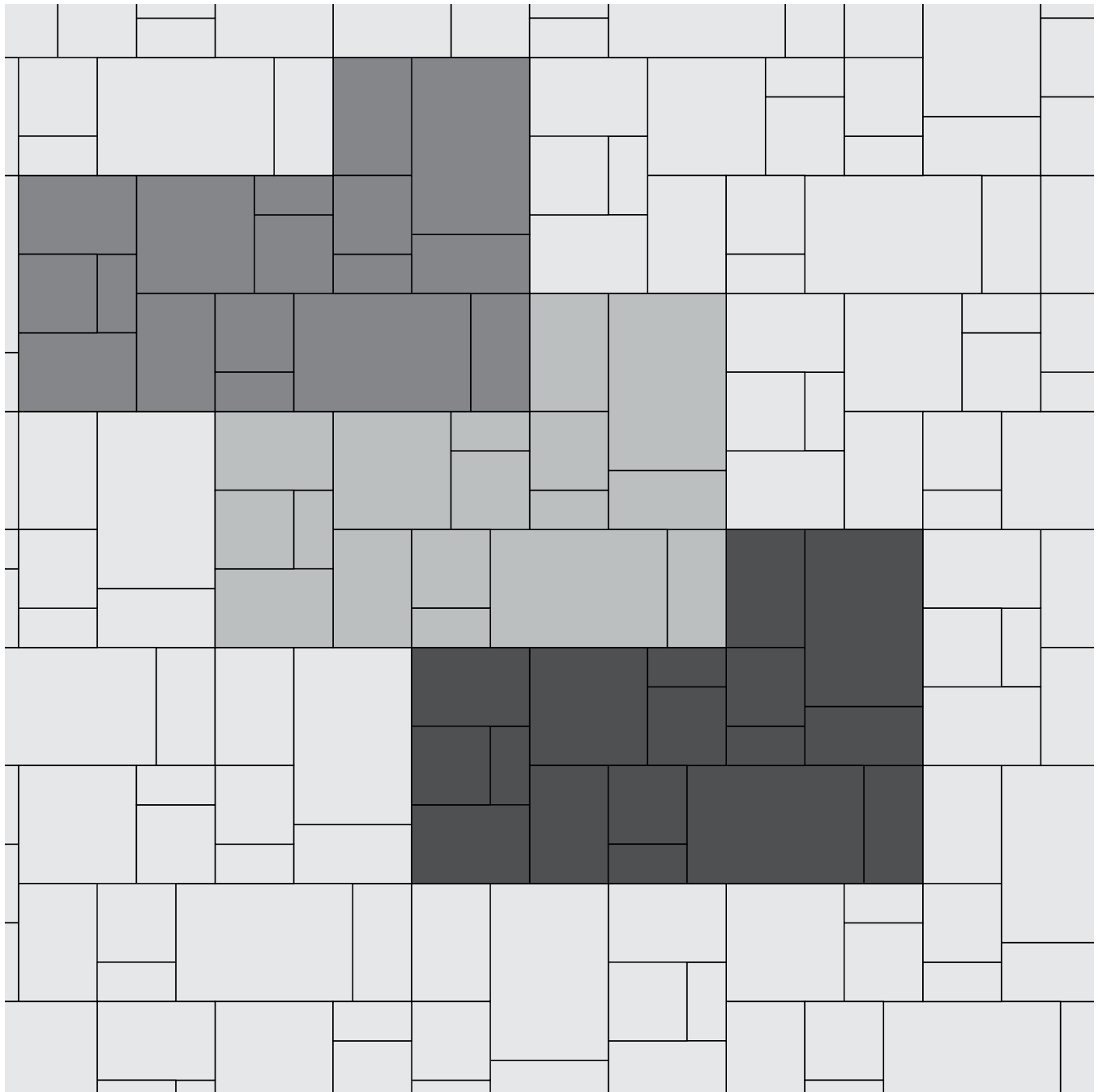

NOTES:

AutoCAD® hatch pattern files can be downloaded from belgard.com for use in architectural drawings.

Some patterns may not necessarily reflect the percentages of stone sizes within a particular pallet. In some cases you may have extras in one or more of the sizes. This must be accounted for in your planning and design.

Percentages are estimated based on area by paver.



MIX PATTERN

*Percentage of surface area (sq. ft)

MIX PATTERN

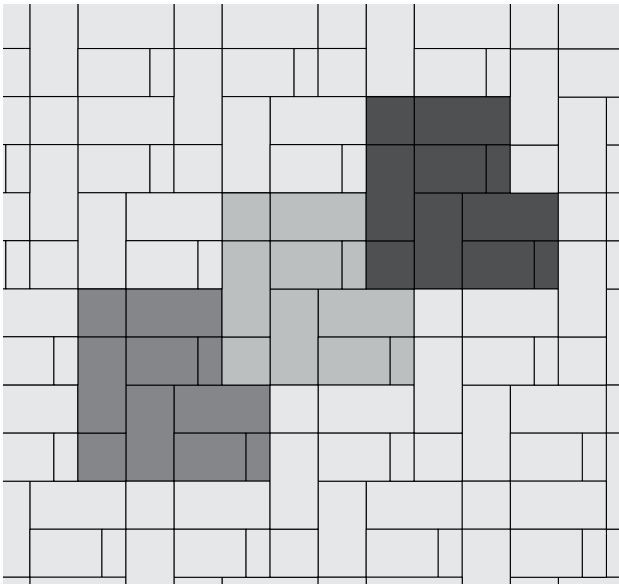

Origins 12 x 24 - 57% | Origins 12 - 43%**

MIX PATTERN

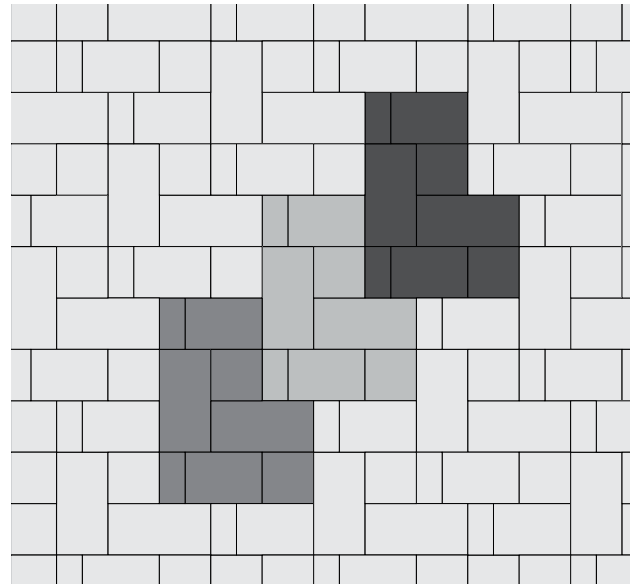

Origins 12 x 24 - 40% | Origins 12 - 60%**

NOTES:

AutoCAD® hatch pattern files can be downloaded from belgard.com for use in architectural drawings.

Some patterns may not necessarily reflect the percentages of stone sizes within a particular pallet. In some cases you may have extras in one or more of the sizes. This must be accounted for in your planning and design.

Percentages are estimated based on area by paver.



MIX PATTERN

*Percentage of surface area (sq. ft)

MIX PATTERN

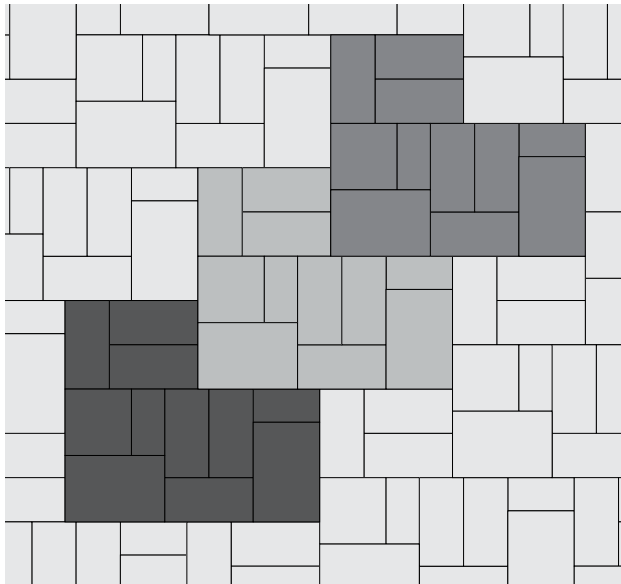

Origins 12 x 24 - 52% | Origins 18 - 48%**



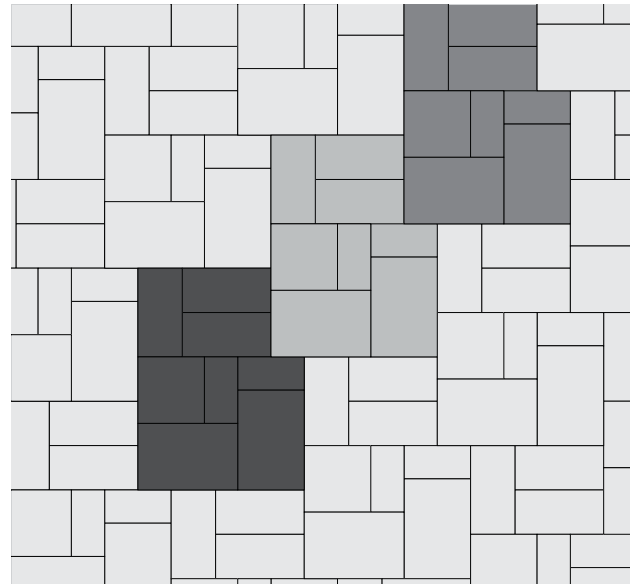

MIX PATTERN



Origins 12 x 24 - 35% | Origins 18 - 65%**



Scan for additional product information

PEDESTRIAN	LIGHT/REGULAR TRAFFIC	HEAVY TRAFFIC	PERMEABLE	ADA
				
✓	✓			

SHAPES & SIZES

3-Piece



3 x 6 x 2³/₈

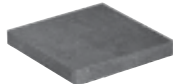

6 x 6 x 2³/₈

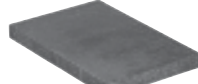

6 x 9 x 2³/₈

UNIT	SQFT/ PALLET	SQFT/ LAYER	LAYER/ PALLET	UNITS/ PALLET	UNITS/ LAYER	UNITS/ SQFT	WEIGHT/ PALLET
3-PIECE							
3 X 6 X 2³/₈	20	2	–	160	16	8	538
6 X 6 X 2³/₈	40	4	–	160	16	4	1076.4
6 X 9 X 2³/₈	60	6	–	160	16	2.67	1614.6
TOTAL	120	12	10	480	48	–	3230



Scan for additional
product information

PEDESTRIAN	LIGHT/REGULAR TRAFFIC	HEAVY TRAFFIC	CORE MIX	DURAFUSION PROCESS	ADA
✓			✓	✓	✓

SHAPES & SIZES

3-Piece



9 x 18 x 2³/₈



18 x 18 x 2³/₈



18 x 27 x 2³/₈

UNIT	SQFT/ PALLET	SQFT/ LAYER	LAYER/ PALLET	UNITS/ PALLET	UNITS/ LAYER	SQFT/ UNIT	WEIGHT/ PALLET	LNFT/PALLET (SOLDIER)	LNFT/PALLET (SAILOR)
------	-----------------	----------------	------------------	------------------	-----------------	---------------	-------------------	--------------------------	-------------------------

3-PIECE

9 X 18 X 2 ³ / ₈	112.5	11.25	10	50	5	—	3152	—	82.5
18 X 18 X 2 ³ / ₈									
18 X 27 X 2 ³ / ₈									



NOTES:

AutoCAD® hatch pattern files can be downloaded from belgard.com for use in architectural drawings

Some patterns may not necessarily reflect the percentages of stone sizes within a particular pallet. In some cases you may have extras in one or more of the sizes. This must be accounted for in your planning and design.

Percentages are based on area by paver.

3-PIECE PATTERN A

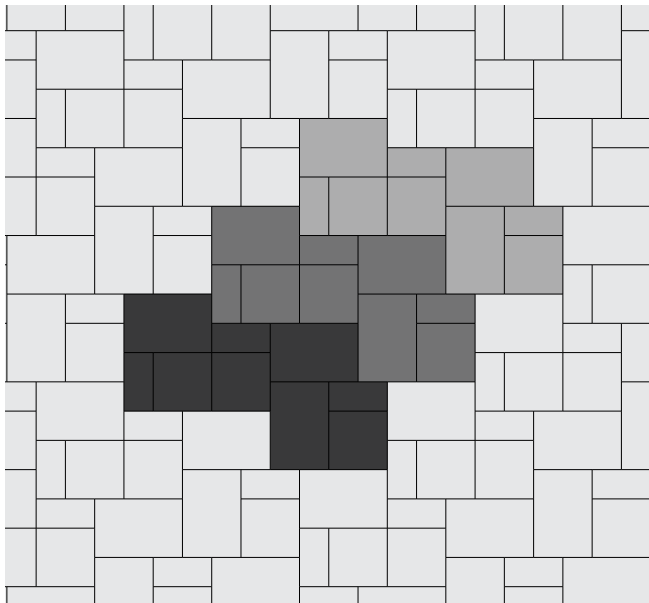

3-PIECE PATTERN B

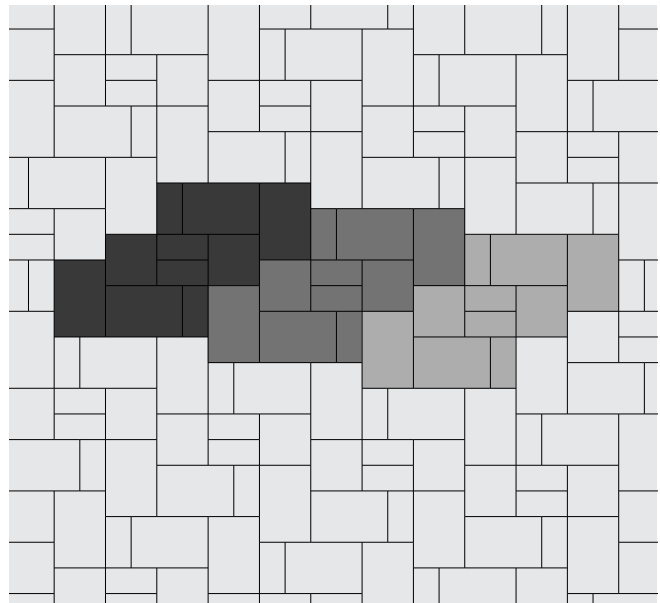

PERMEABLE PAVERS

PERMEABLE PAVER INSTALLATION GUIDE

58 Basic PICP Systems

PERMEABLE PAVERS

59 Aqua Dublin

61 Aqualine™

63 Turfstone™

65 Urbana Stone®

For basic paver installation information
visit masonryandhardscapes.org

PERMEABLE INTERLOCKING CONCRETE PAVEMENT (PICP)

PICP TYPICAL CROSS SECTION

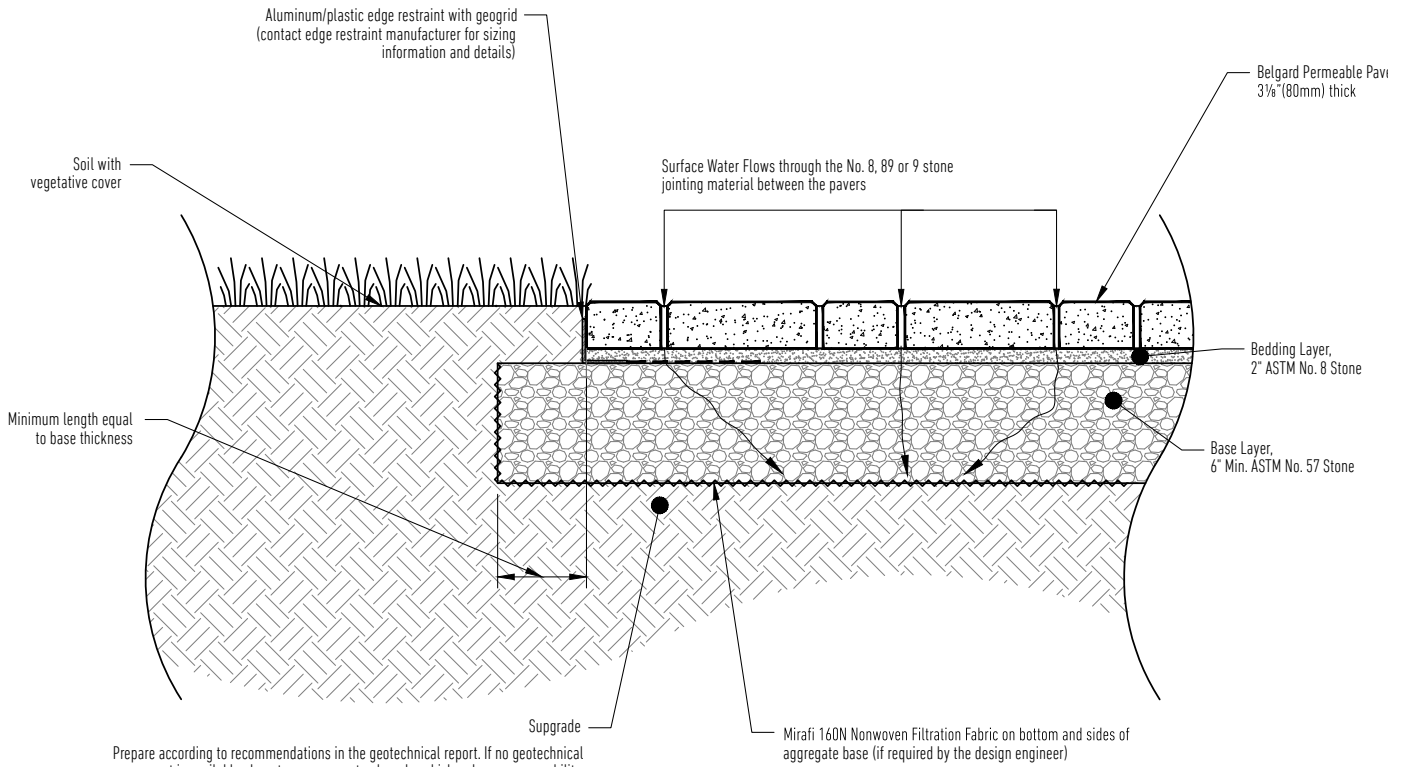
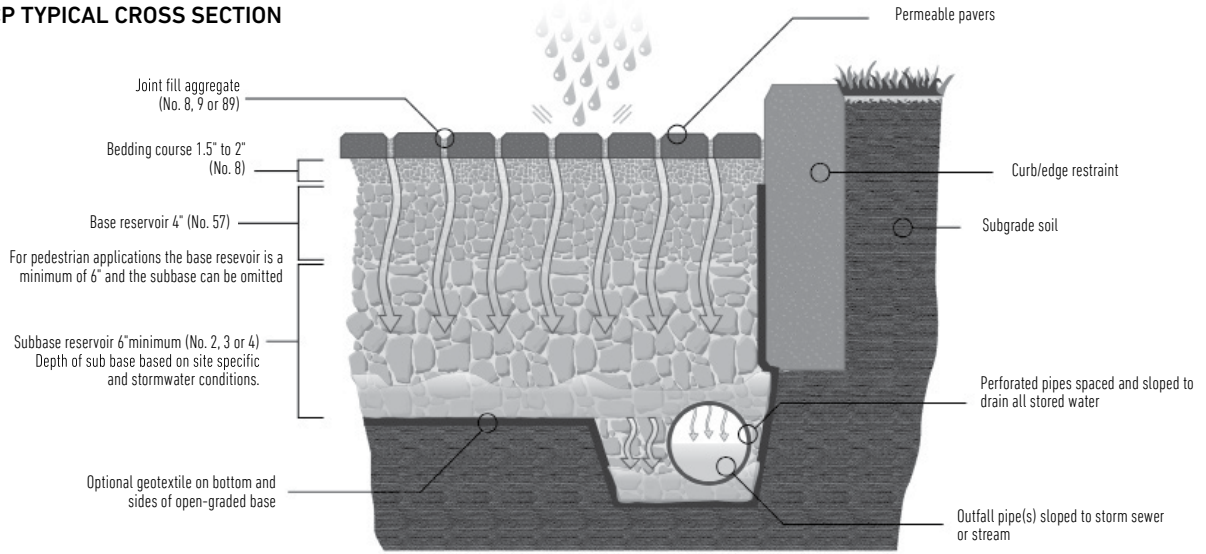

Prepare according to recommendations in the geotechnical report. If no geotechnical report is available, do not over compact subgrade, which reduces permeability, without installing an underdrain to an outlet







Design Notes:

1. Cross section as shown is suitable for pedestrian applications and residential driveways, patios, and sidewalks.
2. Depth of aggregate base subject to site specific conditions (soil conditions, groundwater levels, climatic conditions). Contact local Belgard sales representative.
3. Drain pipes may be required within the aggregate base depending on the permeability of the subgrade soils. Verify drainage needs with the geotechnical engineer. Ensure drain pipes are able to daylight via gravity flow to surface, or connect to catch basin.



Scan for additional product information

**Special Order Only*
Contact your local Belgard representative for more information.

PEDESTRIAN	LIGHT/REGULAR TRAFFIC	HEAVY TRAFFIC	CORE MIX	DURAFUSION PROCESS	ADA	FINISHES		
						SHOT BLAST	GROUND FACE	TUMBLED/ANTIQUED
✓	✓	✓	✓	✓	✓	✓*	✓*	✓*

SHAPES & SIZES

3-Piece

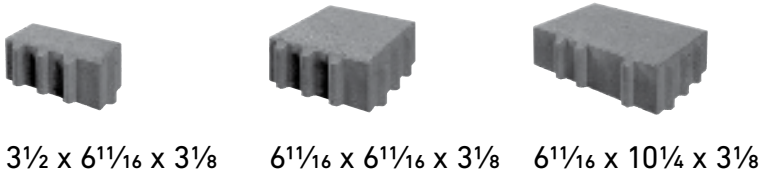

3½ X 6⅛ X 3⅛

6⅛ X 6⅛ X 3⅛

6⅛ X 10¼ X 3⅛

UNIT	SQFT/PALLET	SQFT/LAYER	LAYER/PALLET	UNITS/PALLET	UNITS/LAYER	UNITS/SQFT	WEIGHT/PALLET
3-PIECE							
3½ X 6⅛ X 3⅛	20	2.5	–	120	15	6	712.8
6⅛ X 6⅛ X 3⅛	21.28	2.66	–	64	8	3	745.2
6⅛ X 10¼ X 3⅛	51.12	6.39	–	104	13	2.03	1782
TOTAL	92.4	11.55	8	288	36	–	3240



Available for Mechanical Installation

NOTES:

AutoCAD® hatch pattern files can be downloaded from belgard.com for use in architectural drawings.

Some patterns may not necessarily reflect the percentages of stone sizes within a particular pallet. In some cases you may have extras in one or more of the sizes. This must be accounted for in your planning and design.

Percentages are estimated based on area by paver.

21% $3\frac{1}{2} \times 6\frac{11}{16}$ Rectangles

23% $6\frac{11}{16} \times 6\frac{11}{16}$ Squares

56% $6\frac{11}{16} \times 10\frac{1}{4}$ Rectangles



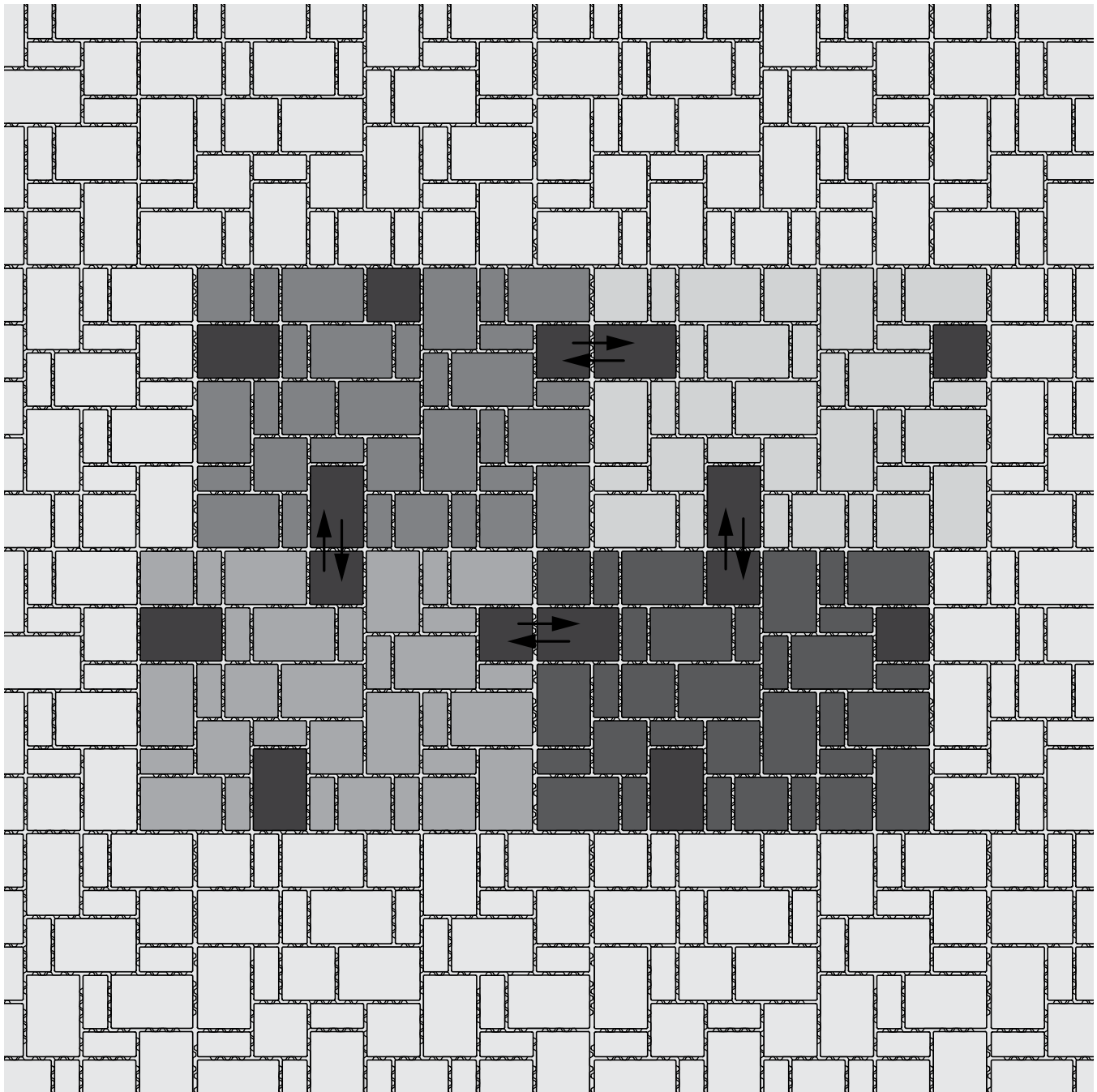



Available for mechanical installation





Scan for additional
product information

**Special Order Only*
Contact your local Belgard representative for more information.

PEDESTRIAN	LIGHT/REGULAR TRAFFIC	HEAVY TRAFFIC	CORE MIX	DURAFUSION PROCESS	ADA	FINISHES		
						SHOT BLAST	GROUND FACE	TUMBLED/ ANTIQUED
✓	✓	✓	✓	✓	✓	✓*	✓*	✓*

SHAPES & SIZES

80mm



4½ x 9 x 3⅛

UNIT	SQFT/ PALLET	SQFT/ LAYER	LAYER/ PALLET	UNITS/ PALLET	UNITS/ LAYER	UNITS/ SQFT	WEIGHT/ PALLET
80MM							
4½ X 9 X 3⅛	90	11.25	8	320	40	3.55	3100

6.9% Voids/.025 CF/SF Infill
ADA Compliant



Available for
Mechanical Installation



NOTES:

AutoCAD® hatch pattern files can be downloaded from belgard.com for use in architectural drawings.

Some patterns may not necessarily reflect the percentages of stone sizes within a particular pallet. In some cases you may have extras in one or more of the sizes. This must be accounted for in your planning and design.

Percentages are estimated based on area by paver.

100% 4½ x 9 Rectangles

1-PIECE HERRINGBONE PATTERN

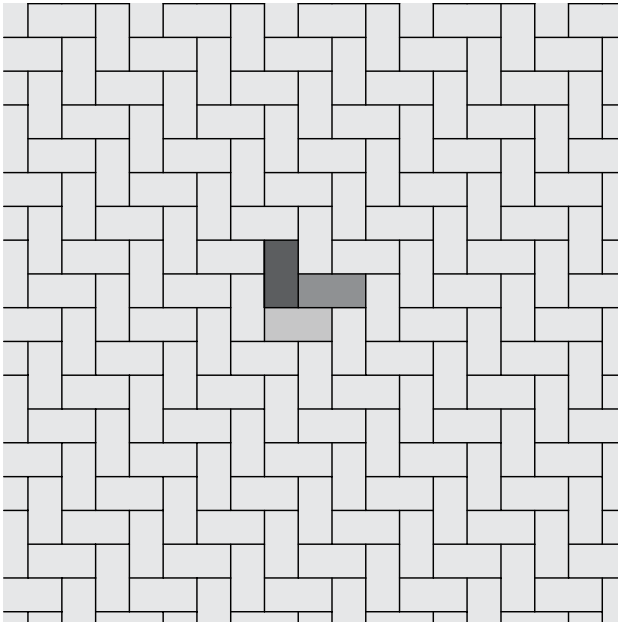

1-PIECE BASKET WEAVE PATTERN

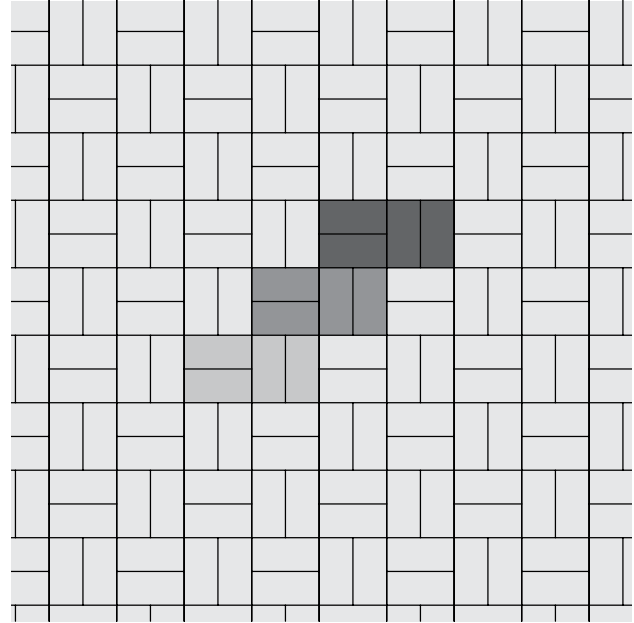



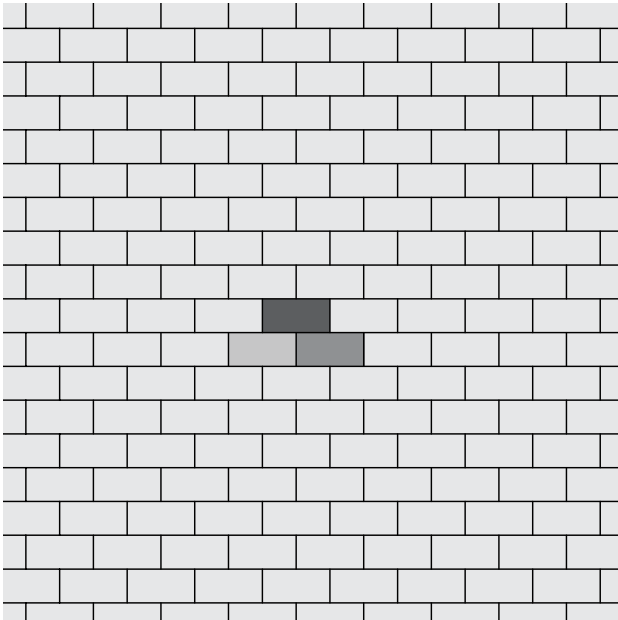



1-PIECE RUNNING BOND PATTERN





Scan for additional
product information

PEDESTRIAN	LIGHT/REGULAR TRAFFIC	HEAVY TRAFFIC	CORE MIX	DURAFUSION PROCESS	ADA	FINISHES		
						SHOT BLAST	GROUND FACE	TUMBLED/ ANTIQUED
✓	✓		✓	✓				

SHAPES & SIZES

Turfstone



16 x 24 x 3 1/8

UNIT	SQFT/ PALLET	SQFT/ LAYER	LAYER/ PALLET	UNITS/ PALLET	UNITS/ LAYER	UNITS/ SQFT	WEIGHT/ PALLET
TURFSTONE							
16 x 24 x 3 1/8	101	10.1	10	40	4	0.38	2680

NOTES:

AutoCAD® hatch pattern files can be downloaded from belgard.com for use in architectural drawings.

Some patterns may not necessarily reflect the percentages of stone sizes within a particular pallet. In some cases you may have extras in one or more of the sizes. This must be accounted for in your planning and design.

Percentages are estimated based on area by paver.

Turfstone grid lines installed facing down.

100% 16 x 24 Pavers

1-PIECE STACK RUNNING BOND PATTERN

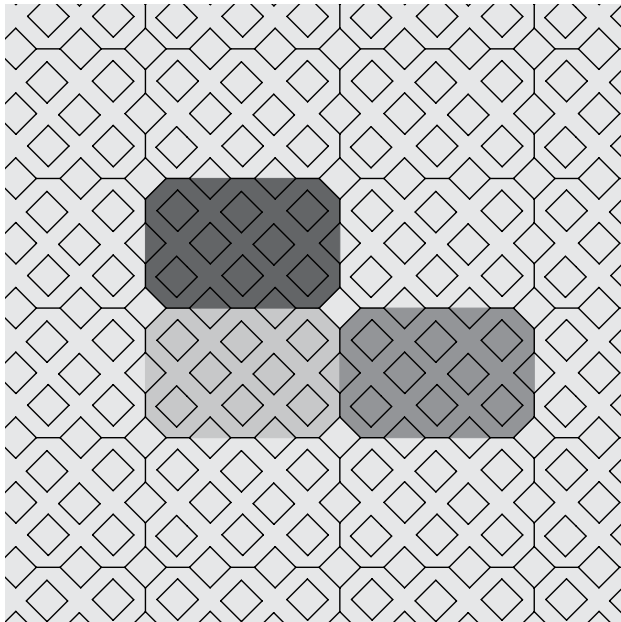



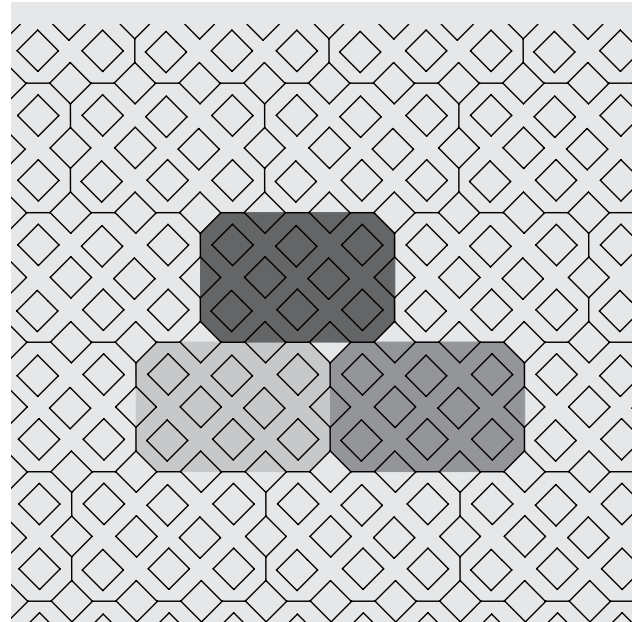



1-PIECE STAGGERED RUNNING BOND PATTERN





Scan for additional
product information

PEDESTRIAN	LIGHT/REGULAR TRAFFIC	HEAVY TRAFFIC	CORE MIX	DURAFUSION PROCESS	ADA	FINISHES		
						SHOT BLAST	GROUND FACE	TUMBLED/ ANTIQUED
✓	✓	✓**	✓	✓				

SHAPES & SIZES

3-Piece Modular**

Large Square**



4 x 8 x 2³/₈

8 x 8 x 2³/₈

12 x 8 x 2³/₈

12 x 12 x 2³/₈

**Available in 80mm Special Order

*Permeable installation requires wider joints and proper base and jointing material. Contact your Belgard Representative for more information.

UNIT	SQFT/ PALLET	SQFT/ LAYER	LAYER/ PALLET	UNITS/ PALLET	UNITS/ LAYER	UNITS/ SQFT	WEIGHT/ PALLET
------	-----------------	----------------	------------------	------------------	-----------------	----------------	-------------------

3-PIECE MODULAR | 60MM

4 X 8 X 2 ³ / ₈	19.4	1.94	–	90	9	4.64	523
8 X 8 X 2 ³ / ₈	38.8	3.88	–	90	9	2.32	1047
12 X 8 X 2 ³ / ₈	58.2	5.82	–	90	9	1.55	1570
TOTAL	116.4	11.64	10	270	27	–	3140

3-PIECE MODULAR | 80MM**

4 X 8 X 3 ¹ / ₈	17.46	1.94	–	81	9	4.64	628
8 X 8 X 3 ¹ / ₈	34.92	3.88	–	81	9	2.32	1257
8 X 12 X 3 ¹ / ₈	52.38	5.82	–	81	9	1.55	1885
TOTAL	104.76	11.64	9	108	27	–	3770

LARGE SQUARE | 60MM

12 X 12 X 3 ¹ / ₈	116.25	11.65	10	120	12	1	3140
---	--------	-------	----	-----	----	---	------

LARGE SQUARE | 80MM**

12 X 12 X 3 ¹ / ₈	104.76	11.65	9	108	12	1	3770
---	--------	-------	---	-----	----	---	------



NOTES:

AutoCAD® hatch pattern files can be downloaded from belgard.com for use in architectural drawings.

Some patterns may not necessarily reflect the percentages of stone sizes within a particular pallet. In some cases you may have extras in one or more of the sizes. This must be accounted for in your planning and design.

Percentages are estimated based on area by paver.

17% 4 x 8 Rectangles

33% 8 x 8 Squares

50% 8 x 12 Rectangles

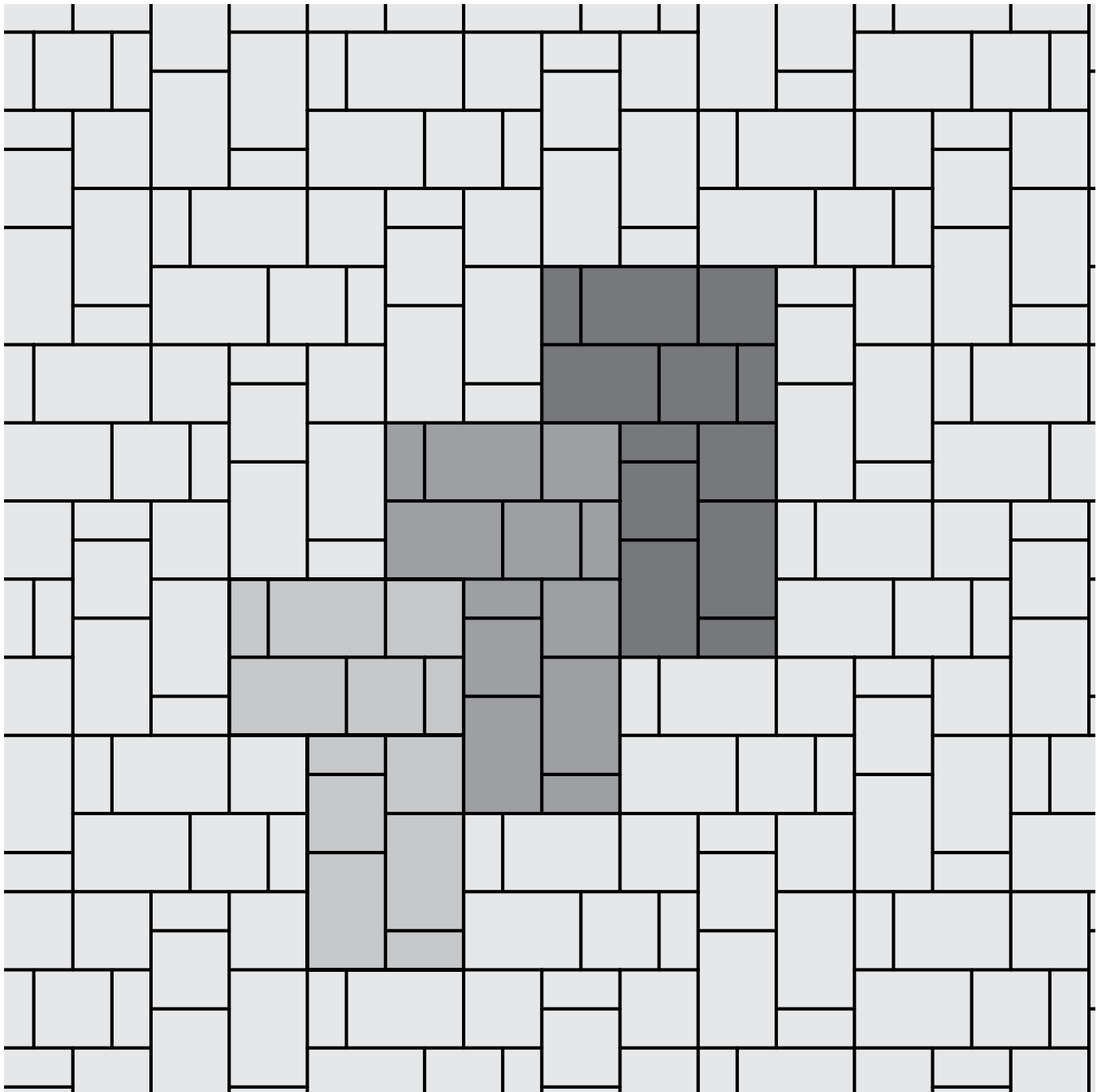



NOTES:

AutoCAD® hatch pattern files can be downloaded from belgard.com for use in architectural drawings.

Some patterns may not necessarily reflect the percentages of stone sizes within a particular pallet. In some cases you may have extras in one or more of the sizes. This must be accounted for in your planning and design.

Percentages are estimated based on area by paver.

17% 4 x 8 Rectangles

33% 8 x 8 Squares

50% 8 x 12 Rectangles

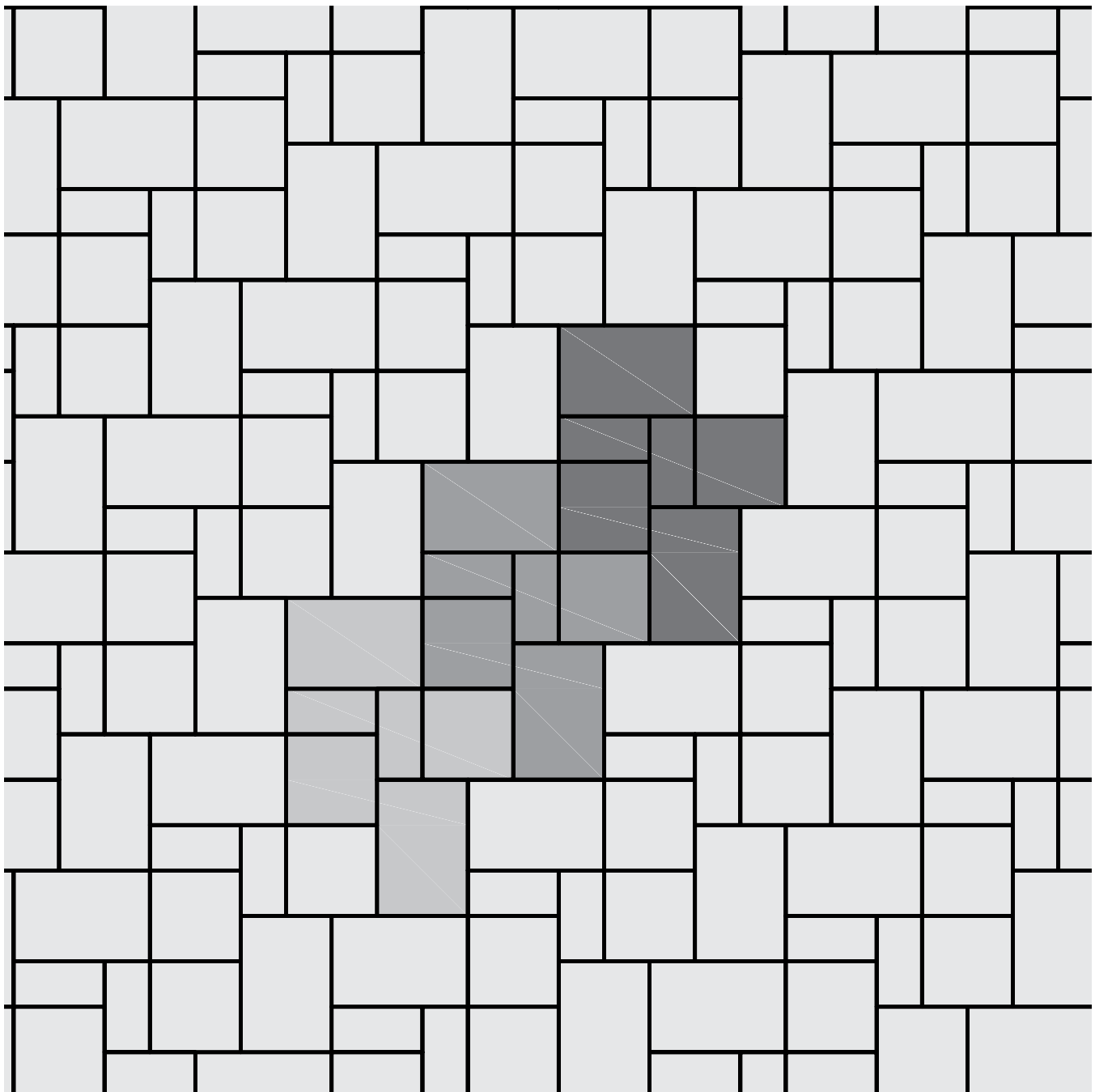



NOTES:

AutoCAD® hatch pattern files can be downloaded from belgard.com for use in architectural drawings.

Some patterns may not necessarily reflect the percentages of stone sizes within a particular pallet. In some cases you may have extras in one or more of the sizes. This must be accounted for in your planning and design.

Percentages are estimated based on area by paver.

80% 3-Piece

20% Large Square

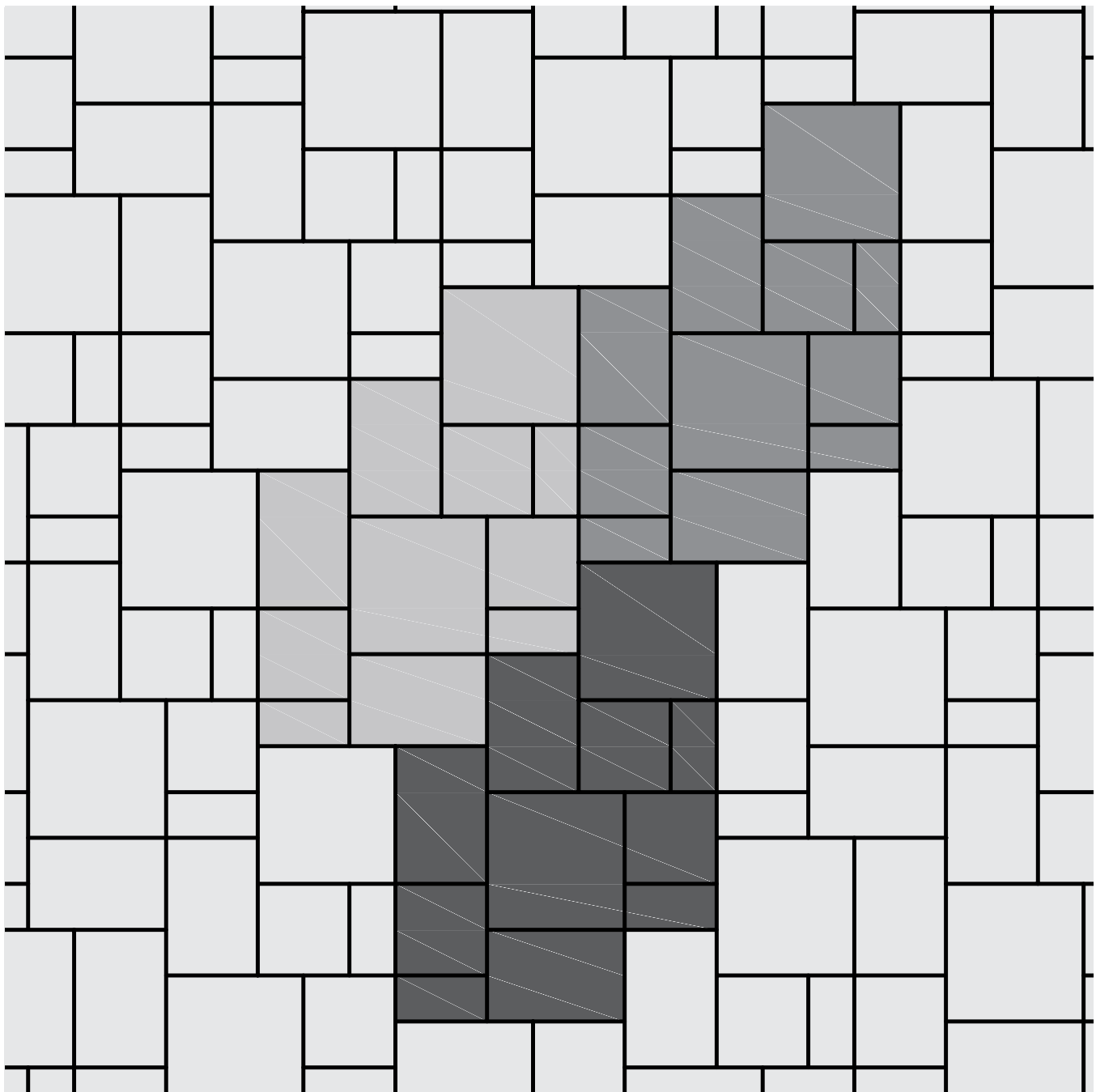

PORCELAIN PAVERS & PLANKS

PORCELAIN INSTALLATION GUIDE

- 70 Porcelain Paver Advantages
- 70 Specialty Tools for Porcelain Pavers Construction
- 71 Cleaning & Maintenance For Porcelain Products
- 71 Porcelain Paver Installation
- 72 Sand Set over Compacted Road Base Installation (Pedestrian Foot Traffic)
- 72 Sand Set over Concrete Overlay Installation (Pedestrian Foot Traffic)
- 73 Gravel Set Over Open Graded Aggregate Installation
- 74 Cementitious Adhesive Overlay, Concrete Base Installation (Light Vehicular Traffic)

PORCELAIN PAVERS & PLANKS

- | | |
|-----------------------|-----------------|
| 75 Elysian Travertini | 80 Lagoon |
| 76 Foundation | 81 Lemmy |
| 77 Genoa | 82 Noon |
| 78 Glocal | 83 Norr |
| 79 Jurupa | 84 Quarziti 2.0 |
| | 85 Silverlake |

For basic paver installation information
visit masonryandhardscapes.org

PORCELAIN PAVERS

Belgard Porcelain Pavers are formed by pressing, followed by vitrification: this process involves the total fusion into a single material made from natural raw materials (sand, quartz, feldspars, kaolin, clays and inorganic pigments) which, fired at temperatures above 1226.67° C (2240° F), are transformed into a product with exceptional hardness, ultra-low absorption rate and unmatched mechanical characteristics. Belgard porcelain pavers are eco-compatible and ecolabel-certified. Each unit is 20mm (0.7874") standard thickness or ¾" nominal thickness and is durable enough to withstand use in exterior applications.

PORCELAIN PAVERS ADVANTAGES:

- **Freeze thaw resistant**—They are 100% frost-free and their properties remain unaltered at temperatures ranging from -51.1° to + 60° C (-60° F to +140°F).
- **Color durability**—Color is fused by vitrification, becomes an integral part of the porcelain surface and is not affected by elements.
- **Easy installation**—Perfect fit and for fast installs.
- **Low absorption rate**—Spills, salt and other materials will not seep into pours.
- **Easy to clean**—Household cleaners can be used to wipe down spills and dirt; can even be pressure washed with a low pressure washing device* (see pressure washing warning below).*
- **Stylish**—Matches what homeowners are currently doing inside the home.
- **Durable**—High breakage loads of up to 3,587 lbs (1,627 kg) per foot based on ASTM-C648.
- **Resistant**— High compressive strength and ultra-low absorption rate creates a dense surface that resists mold, moss, dirt and other staining.
- **Skid-resistant**—Structured paver top textures create slip resistant surfaces for safety; perfect for around pools/spas or in wet climates.
- **Modular Design**—Superior accuracy in dimensional sizing and linear sides, the slabs allow for perfectly executed installations with tight and accurate lines.
- **Light weight**—16.8 kg (37 lbs) for the 24"x24" paver permit for easy installation, removal and serviceability and even reusability (Excluding adhered installations).
- Available in colors that have an SRI that qualifies for a LEED certification. The SRI on some units ranges between 60-80. To receive LEED credit, the SRI must be at least 29.
- **Impermeable**— Deicing salt and other deicing materials can be used without concern of damage.

* It is important that all pressure washing of your porcelain pavers be done with a low pressure washer with a maximum of 1600 psi and nothing more powerful. When pressure washing your installation, care should be taken to prevent damage to the grout (adhesive and grout installations) and some re-sanding will be necessary when power washing an installation with sand or polymeric sand joints.

SPECIALTY TOOLS FOR PORCELAIN PAVER CONSTRUCTION:

- Wet cut tile saw equipped with a diamond blade manufactured for wet cutting porcelain. The saw should be designed to safely cut a 24 inch length porcelain paver.
- A paver clamp for easy handling, which can be used to both install and remove pavers.
- The use of gloves is highly recommended while handling and installing porcelain slabs.
- Appropriate notched trowels and grout float tools for cementitious adhesive and grout installation. The appropriate tool selection would be based on the adhesive and grout manufacturer's recommendation
- Pallets of porcelain pavers are manufactured and shipped with a Heavy Duty plastic protective pallet cover and the individual porcelain pavers are packaged in protective cardboard boxes. To prevent damage to your pavers, do not remove the protective cardboard boxes until you are ready to install them.
- Caution: Removing pavers from their protective packaging and handling multiple loose stones together creates the possibility for chipping.

Once the Heavy Duty plastic pallet covers have been removed from the pallet, the unused boxed pavers should be protected from the elements to insure the integrity of the protective cardboard boxes.

CLEANING & MAINTENANCE FOR PORCELAIN PRODUCTS

Post-laying cleaning is obligatory after on site works. Inadequate or late removal of the grouting used on the joints can leave marks difficult to remove and create, on the flooring, a cement film able to absorb all types of dirt, thus giving the impression that it is the material that has become dirty.

It is indispensable to dissolve and remove these residues completely using buffered acids diluted in water (follow the instructions on the packs of the products used), which must then be removed completely and quickly, rinsing the floor with plenty of water to avoid residues or drops on the floor which could damage the tiles.

Allow the product to act on the wet floor, without letting it dry and rubbing it with colorless rags. Next, rinse it thoroughly with water to ensure that the floor is free of detergent residues. If necessary, repeat the operation.

We suggest performing a preliminary wash on a sample surface of a few square meters; if the test is successful, extend clearing over the entire surface. When you have done the above wash, carry out a basic or alkaline wash using degreasing detergents. This is because acid can leave grease on the floor, which could contribute to retaining dirt.

PORCELAIN PAVER INSTALLATION

Each of the following option details will include specific information relative to the selected installation. Base thicknesses vary between different geographical and climatic locations and the contractor will be installing typical base thicknesses for paving installations in their location.

Installing porcelain pavers requires the bedding course sand to be pre-compacted and then struck off with a screed to the required thickness as shown in the detail drawings. The porcelain pavers are not compacted and therefore the sand layer beneath them requires pre-compaction. Do not compact dry sand, but insure the sand has a 5 to 6% moisture content so that it will compact cohesively and allow for a smooth strike off finish.

INSTALLATION INFORMATION THAT MUST BE FOLLOWED:

- Weather, soil type and job conditions should be considered when choosing the best installation method.
- When installing porcelain planks (12 x 48, 8 x 48) always lay the pattern of the 1/3s. These should not be placed next to each other at 50%
- NEVER compact porcelain pavers with a plate compactor. Roller compactor recommended for all compaction with porcelain products
- ALWAYS pre-compact and strike off your sand leveling course before installing your porcelain pavers in sand set installations.
- A proper surface drainage system is required to mitigate standing water. Please consider that Belgard Porcelain Paves are impervious, therefore water must be properly discharged and drained away from the pavement.
- Porcelain pavers should only be wet cut with a tile saw equipped with a wet cut porcelain blade.
- NEVER install porcelain pavers without the required 4mm spacing between them. The porcelain pavers should never be installed with a porcelain to porcelain contact. Plastic 4mm spacers (shown at right) should be used on Sand Set and Permeable installations. The photo on the left illustrates the spacer installed in a perspective to support and space 4 paver corners and the photo on the right illustrates the installed spacer snapped apart (as designed) to form Space T that supports 2 paver corners. This versatility will permit your porcelain pavers to be installed in a stack bond pattern, a running bond patterns as well as a flush installation against another structure.
- For a 100 sf. project, approximately 34 spacers are needed; this allows for overages if needed.

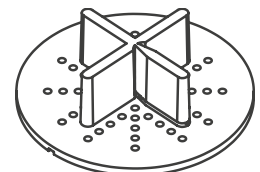

4mm spacers



SAND SET OVER COMPACTED ROAD BASE INSTALLATION (PEDESTRIAN FOOT TRAFFIC)

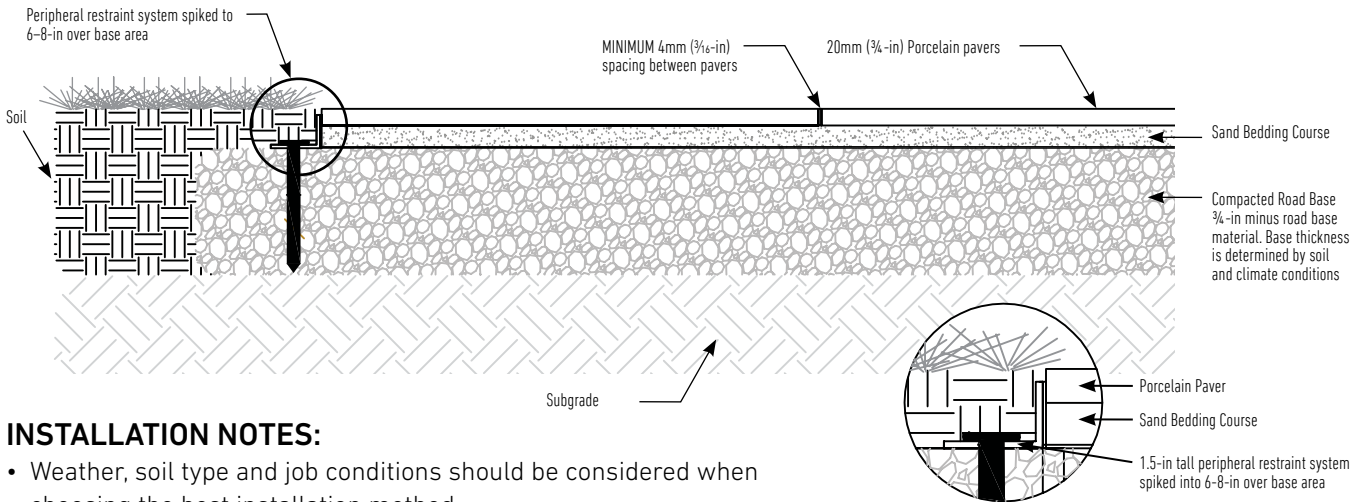

INSTALLATION NOTES:

- Weather, soil type and job conditions should be considered when choosing the best installation method.
- Follow the detailed drawing above
- Base material is to be over based 6 to 8 inches beyond the edge of the pavement.
- Precompact the sand bedding course and screed to 1-in thickness with smooth surface
- The required edge restraint system is a low profile edge restraint with a vertical height of 1 1/2-in as shown in the drawing.
- Insure that pavement is constructed with a 1 1/2 to 2% slope that it is pitched away from any building.
- Insure the plastic 4mm spacers are installed at all corners of the installed pavers

SAND SET OVER CONCRETE OVERLAY INSTALLATION (PEDESTRIAN FOOT TRAFFIC)

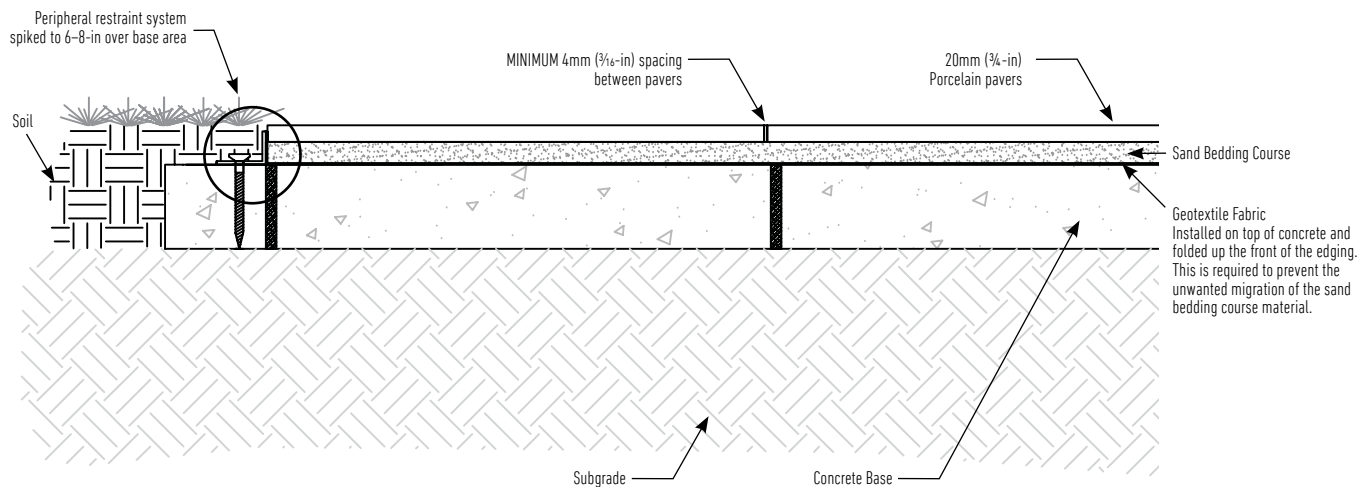

INSTALLATION NOTES:

- Weather, soil type and job conditions should be considered when choosing the best installation method.
- A concrete curb with a full depth and finished height is needed to ensure full containment of the bedding sand and the Belgard Porcelain Pavers.
- Precompact the sand bedding course and screed to 1-in thickness with smooth surface
- Mechanically anchor edge restraint into the concrete base.
- Insure geotextile is installed directly on top of the concrete to contain the bedding sand.
- Insure that pavement is constructed with a 1 1/2 to 2 percent slope and that it is pitched away from any building.
- Insure the plastic 4mm spacers are installed at all corners of the installed pavers.

GRAVEL SET OVER OPEN GRADED AGGREGATE INSTALLATION

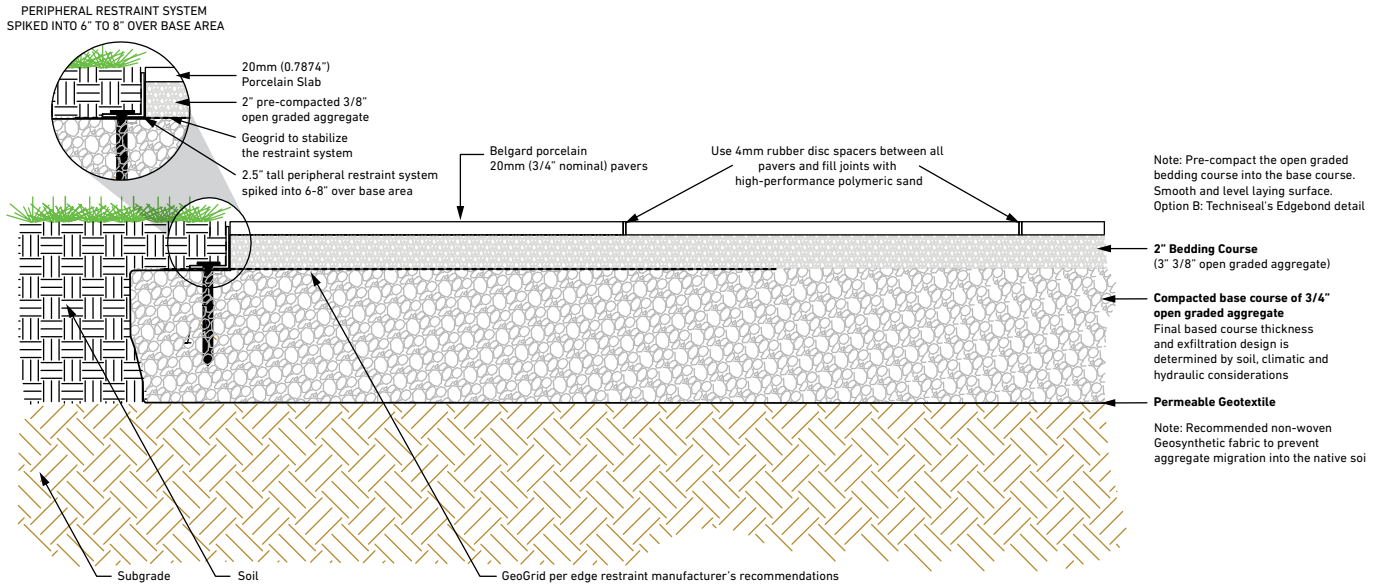

INSTALLATION NOTES:

- Weather, soil type and job conditions should be considered when choosing the best installation method. Follow the detail drawing.
- The required edge restraint system for this installation has a vertical height of 2½ inches as shown in the drawing. Follow the edge restraint manufacturer’s recommendations for the use of their product in permeable applications regarding geogrid usage and placement to maintain the performance of there edging.
- Ensure that pavement is constructed with a 2% slope and that it is pitched away from any building.
- Ensure the 4mm spacers are installed between all pavers.
- The open-graded aggregate should be clean and free from foreign matter, manufactured from crushed rock and conform to ASTM C33 size No. 57. Do not use recycled aggregates or rounded river gravel.
- Additional Drainage: If the project has fine-grained soils, silts or clays, and contributing water sources such as downspouts or groundwater, it is important to install a perforated pipe underdrain to prevent saturation of the subgrade. Make sure underdrain has an acceptable discharge location.
- When installing porcelain planks (12 x 48 & 8 x 48), always lay the pattern of 1/3's. These should not be placed next to each other at 50%.
- Roller Compactor recommended for all compaction with Porcelain products

CEMENTITIOUS ADHESIVE OVERLAY, CONCRETE BASE INSTALLATION (LIGHT VEHICULAR TRAFFIC)

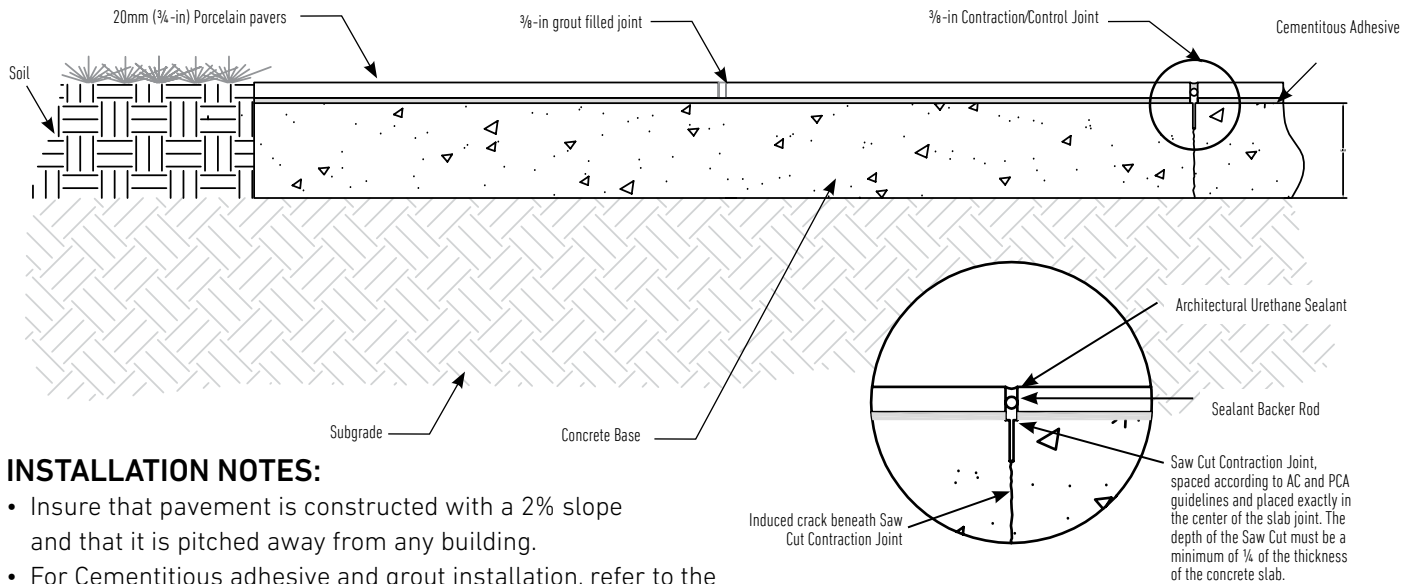

INSTALLATION NOTES:

- Insure that pavement is constructed with a 2% slope and that it is pitched away from any building.
- For Cementitious adhesive and grout installation, refer to the manufacturer's technical instructions and specifically as they relate to outdoor installations.
- For concrete foundation slabs that are not large enough to require contraction / control joints, a minimum 4mm (1/8" to 3/16") grout joint is acceptable, but for larger concrete foundation slabs that do require contraction / control joints, the joint width should be a 3/8". It is absolutely imperative that all contraction / control joints be located in the joint line of installed porcelain pavers and not beneath a paver.
- Caution: If a Porcelain Paver is installed over a control joint, the paver will reflectively crack along the contraction / control joint beneath it.

ELYSIAN TRAVERTINI





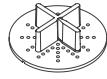

PORCELAIN COLLECTION 



Scan for additional product information



Spacers are recommended for all porcelain paver installations.

PEDESTRIAN	LIGHT/REGULAR TRAFFIC	HEAVY TRAFFIC	CORE MIX	DURAFUSION PROCESS	ADA
					
✓			✓	✓	

SHAPES & SIZES

32 x 32



31.5 x 31.5 x 3/4

24 x 48



23.54 x 47.17 x 3/4

UNIT	SQFT/PALLET	PCS/BOX	SQFT/BOX	BOXES/PALLET	UNITS/LAYER	UNITS/SQFT	WEIGHT/PALLET
32 X 32							
31.42 X 31.42 X 3/4	289.33	1	6.89	42	–	–	2751
24 X 48							
23.54 X 47.17 X 3/4	271.25	1	7.75	35	–	–	2621

FOUNDATION



Scan for additional product information

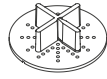

Spacers are recommended for all porcelain paver installations.
PLEASE NOTE: For vehicular applications, must be a mortar install over a concrete slab.
Please refer to the porcelain install guide for driveway install procedure.

PEDESTRIAN	LIGHT/REGULAR TRAFFIC	HEAVY TRAFFIC	CORE MIX	DURAFUSION PROCESS	ADA
✓	✓*		✓	✓	✓

SHAPES & SIZES

24 X 24



23.54 x 23.54 x 3/4

UNIT	SQFT/PALLET	PCS/BOX	SQFT/BOX	BOXES/PALLET	UNITS/LAYER	UNITS/SQFT	WEIGHT/PALLET
24 X 24							
23.54 X 23.54 X 3/4	275.04	2	7.64	36	–	–	2533.8

GENOA



Scan for additional product information

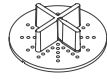

Spacers are recommended for all porcelain paver installations.
PLEASE NOTE: For vehicular applications, must be a mortar install over a concrete slab.
Please refer to the porcelain install guide for driveway install procedure.

PEDESTRIAN	LIGHT/REGULAR TRAFFIC	HEAVY TRAFFIC	CORE MIX	DURAFUSION PROCESS	ADA
✓	✓*		✓	✓	✓

SHAPES & SIZES

12 X 24



11.73 x 23.54 x 3/4

24 X 24*



23.54 x 23.54 x 3/4

UNIT	SQFT/PALLET	PCS/BOX	SQFT/BOX	BOXES/PALLET	UNITS/LAYER	UNITS/SQFT	WEIGHT/PALLET
12 X 24							
11.73 X 23.54 X 3/4	303.6	4	7.59	40	–	–	2807
24 X 24*							
23.54 X 23.54 X 3/4	275.04	2	7.64	36	–	–	2533.8

GLOCAL



Scan for additional product information

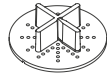

Spacers are recommended for all porcelain paver installations.
PLEASE NOTE: For vehicular applications, must be a mortar install over a concrete slab.
Please refer to the porcelain install guide for driveway install procedure.

PEDESTRIAN	LIGHT/REGULAR TRAFFIC	HEAVY TRAFFIC	CORE MIX	DURAFUSION PROCESS	ADA
✓	✓*		✓	✓	✓

*Porcelain must be wet laid on concrete and concrete must be designed by an engineer to support the traffic load that will be imposed.
**Special Order

SHAPES & SIZES

24 X 24*

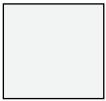

23.54 x 23.54 x 3/4

24 x 48

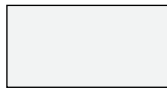

23.54 x 47.17 x 3/4

48 x 48**



47.17 x 47.17 x 3/4

Unico

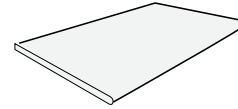

12.99 x 23.54 x 3/4

UNIT	SQFT/PALLET	PCS/BOX	SQFT/BOX	BOXES/PALLET	UNITS/LAYER	UNITS/SQFT	WEIGHT/PALLET
24 X 24*							
23.54 X 23.54 X 3/4	232.5	2	7.75	30	–	–	2160
24 X 48							
23.54 X 47.17 X 3/4	271.25	1	7.75	35	–	–	2621
48 X 48**							
47.17 X 47.17 X 3/4	279	1	15.5	18	–	–	2774.2
UNICO							
12.99 X 23.54 X 3/4	240 LF	3	6 LF	40	–	–	2080

JURUPA



Scan for additional product information

PEDESTRIAN	LIGHT/REGULAR TRAFFIC	HEAVY TRAFFIC	CORE MIX	DURAFUSION PROCESS	ADA
✓	✓*		✓	✓	✓

SHAPES & SIZES

12 x 48

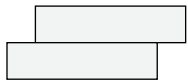

11.73 x 47.17 x 3/4

24 X 24*



23.54 x 23.54 x 3/4

**Light vehicular 24 x 24 only. Porcelain must be wet laid on concrete and concrete must be designed by an engineer to support the traffic load that will be imposed.*

UNIT	SQFT/PALLET	PCS/BOX	SQFT/BOX	BOXES/PALLET	UNITS/LAYER	UNITS/SQFT	WEIGHT/PALLET
24 X 24*							
23.54 X 23.54 X 3/4	232.5	2	7.75	30	–	–	2160
12 X 48							
11.73 x 47.17 x 3/4	279	2	7.75	36	–	–	2664

LAGOON



Scan for additional product information

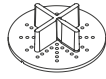

Spacers are recommended for all porcelain paver installations. Please refer to the MIRAGE install guide for driveway install procedure.

PEDESTRIAN	LIGHT/REGULAR TRAFFIC	HEAVY TRAFFIC	CORE MIX	DURAFUSION PROCESS	ADA
✓			✓	✓	✓

SHAPES & SIZES

24 X 48



23.54 x 47.17 x 3/4

UNIT	SQFT/PALLET	PCS/BOX	SQFT/BOX	BOXES/PALLET	UNITS/LAYER	UNITS/SQFT	WEIGHT/PALLET
24 X 48							
23.54 X 47.17 X 3/4	271.25	1	7.75	35	–	–	2621

LEMMY



Scan for additional product information

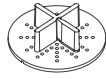

Spacers are recommended for all porcelain paver installations. Please refer to the MIRAGE install guide for driveway install procedure.

PEDESTRIAN	LIGHT/REGULAR TRAFFIC	HEAVY TRAFFIC	CORE MIX	DURAFUSION PROCESS	ADA
✓			✓	✓	✓

SHAPES & SIZES

32 x 32

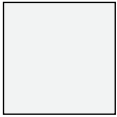

31.5 x 31.5 x 3/4

UNIT	SQFT/PALLET	PCS/BOX	SQFT/BOX	BOXES/PALLET	UNITS/LAYER	UNITS/SQFT	WEIGHT/PALLET
31.5 X 31.5							
31.5 X 31.5 X 3/4	289.33	1	6.89	42	–	–	2751

NOON



Scan for additional product information

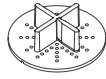

Spacers are recommended for all porcelain paver installations. Please refer to the MIRAGE install guide for driveway install procedure.

PEDESTRIAN	LIGHT/REGULAR TRAFFIC	HEAVY TRAFFIC	CORE MIX	DURAFUSION PROCESS	ADA
✓			✓	✓	✓

SHAPES & SIZES

12 x 48

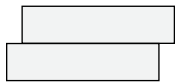

11.73 x 47.17 x 3/4

Unico

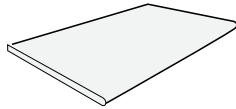







12.99 x 23.54 x 3/4

UNIT	SQFT/PALLET	PCS/BOX	SQFT/BOX	BOXES/PALLET	UNITS/LAYER	UNITS/SQFT	WEIGHT/PALLET
12 X 48							
11.73 x 47.17 x 3/4	279	2	7.75	36	–	–	2664
UNICO							
12.99 X 23.54 X 3/4	240 LF	3	6 LF	40	–	–	2080



Scan for additional
product information

PEDESTRIAN	LIGHT/REGULAR TRAFFIC	HEAVY TRAFFIC	CORE MIX	DURAFUSION PROCESS	ADA
					
✓			✓	✓	

SHAPES & SIZES

32 x 32

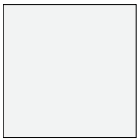

31.5 x 31.5 x 3/4

UNIT	SQFT/ PALLET	PCS/ BOX	SQFT/ BOX	BOXES/ PALLET	UNITS/ LAYER	SQFT/ UNIT	WEIGHT/ PALLET
32 X 32							
31.42 X 31.42 X 3/4	289.33	1	6.89	42	–	–	2751

QUARZITI 2.0



Scan for additional product information

PEDESTRIAN	LIGHT/REGULAR TRAFFIC	HEAVY TRAFFIC	CORE MIX	DURAFUSION PROCESS	ADA
✓	✓*		✓	✓	✓

*Porcelain must be wet laid on concrete and concrete must be designed by an engineer to support the traffic load that will be imposed.
**Special Order

SHAPES & SIZES

12 x 24	18 x 36**	24 x 24*	24 x 48	Unico
11.73 x 23.54 x 3/4	17.64 x 35.35 x 3/4	23.54 x 23.54 x 3/4	23.54 x 47.17 x 3/4	12.99 x 23.54 x 3/4

UNIT	SQFT/ PALLET	PCS/ BOX	SQFT/ BOX	BOXES/ PALLET	UNITS/ LAYER	UNITS/ SQFT	WEIGHT/ PALLET
12 X 24							
11.73 X 23.54 X 3/4	232.4	3	5.81	40	-	-	2178
18 X 36**							
17.64 X 35.35 X 3/4	234.9	2	8.7	27	-	-	2198
24 X 24*							
23.54 X 23.54 X 3/4	232.5	2	7.75	30	-	-	2160
24 X 48							
23.54 X 47.17 X 3/4	271.25	1	7.75	35	-	-	2621
UNICO							
12.99 X 23.54 X 3/4	240 LF	3	6 LF	40	-	-	2080

SILVERLAKE



Scan for additional product information

PEDESTRIAN	LIGHT/REGULAR TRAFFIC	HEAVY TRAFFIC	CORE MIX	DURAFUSION PROCESS	ADA
✓	✓*		✓	✓	✓

SHAPES & SIZES

24 x 24*

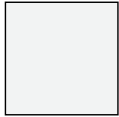

23.54 x 23.54 x 3/4

24 x 48



23.54 x 47.17 x 3/4

UNIT	SQFT/PALLET	PCS/BOX	SQFT/BOX	BOXES/PALLET	UNITS/LAYER	UNITS/SQFT	WEIGHT/PALLET
24 X 24*							
23.54 X 23.54 X 3/4	232.5	2	7.75	30	–	–	2160
24 X 48							
23.54 X 47.17 X 3/4	271.25	1	7.75	35	–	–	2621

WALLS

WALL INSTALLATION GUIDE

- 87 Wall Types
- 88 Before You Begin

WALLS

- | | | | |
|-----|----------------------------|-----|------------------|
| 106 | Ashlar Tandem™ | 118 | Melville Tandem™ |
| 107 | Belair Wall® 2.0 | 119 | Melville™ Wall |
| 111 | Castlemanor® | 120 | Shelton Wall™ |
| 113 | Diamond® 9D | 121 | Steeple Crest™ |
| 114 | Diamond Pro® Straight Face | 123 | Weston Stone™ |
| 115 | Highland Stone® | | |

For basic wall installation information
visit masonryandhardscapes.org



CHMA Segmental Retaining Wall
Installation Guide

SEGMENTAL RETAINING WALL TYPES

Segmental retaining walls typically fall into one of three categories.

GRAVITY RETAINING WALL

The first category — a gravity wall — is a retaining wall that does not use soil reinforcement. A gravity wall has height limitations specific to each product and project. An advantage of this type of retaining wall is that it requires a smaller work area behind the wall. A gravity wall relies on the weight, depth and setback of the block to resist the soil forces being exerted on the wall.

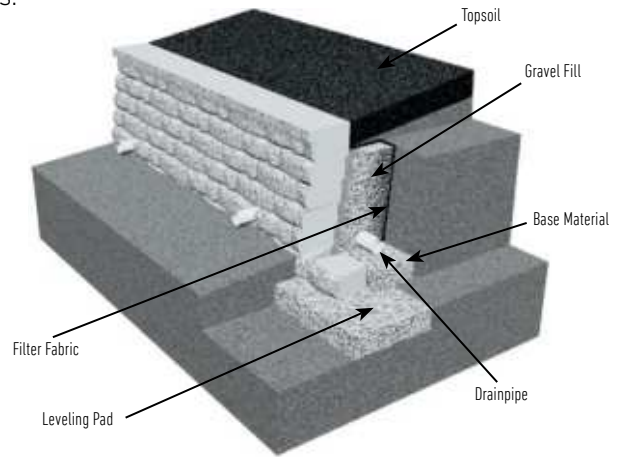

GEOSYNTHETIC-REINFORCED RETAINING WALL

The second category is a geosynthetic-reinforced wall, which needs to be designed by a qualified engineer. There are (theoretically) no height limitations with reinforced retaining walls, and they are used in larger applications. It requires more work area behind the structure.

The block of soil is stabilized by introducing reinforcement layers into the soil mass behind the facing units. The larger the stabilized soil mass, the more soil can be retained or held back. The geogrid in the soil extends past the theoretical failure plane and serves to create a large, coherent gravity mass of block, geogrid, and soil, to resist the forces exerted by the retained soil.

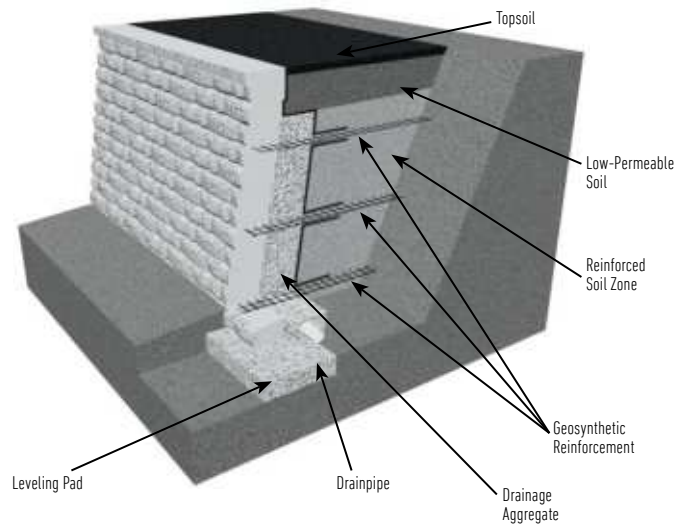

ANCHORPLEX® SYSTEM

The third category is the Anchorplex system, which offers a unique, non-conventional solution to problematic wall construction sites. It is a retaining wall built with Oldcastle™ products and structural backfill specified by ANCHOR Diamond®, and backed by engineering support tools developed by ANCHOR Diamond.

Use of the Anchorplex system eliminates the need for the geogrid and requires substantially less excavation that is usually necessary in geosynthetic-reinforced wall construction.

Contact ANCHOR Diamond at 1-877-295-5415 for more information about designing and building with the Anchorplex system.

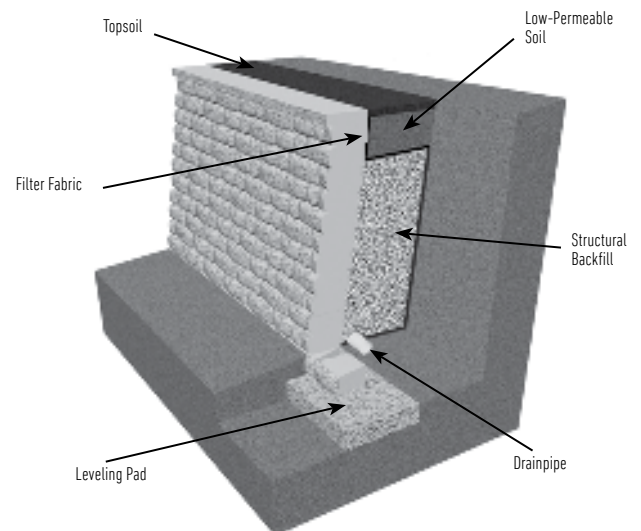

BEFORE YOU BEGIN

Advance planning and careful layout at the job site help ensure a successful retaining and freestanding wall project.

- Review the site plan to confirm lot lines, wall location, length and elevations.
- Understand on-site soils. Ideal soils are sand and gravel. For walls built in clay or poor soils, work with a local engineer to confirm the wall design and the required soil reinforcement. Black or organic soils should not be used as backfill.
- Confirm the location of underground utilities. Call 811.
- Seek all necessary building permits.
- Prepare a drawing of the site with the wall location, lengths and elevations.
- Plan drainage to avoid erosion or buildup of water behind the wall. Consider where the water will drain through the wall, where downspouts will expel and whether there's an underground sprinkler. For walls greater than three feet in height, a perforated drainpipe is recommended at the base of the aggregate to quickly remove large amounts of water.
- A best practice is to divert water away from the wall before it has an opportunity to enter the reinforced soil and gravel fill zone.
- Check the block delivered to ensure it is the correct product and color. Check the geogrids to confirm that it's the strength and weight specified in the engineering plans.
- Be sure to use the right tools. Hand tools include a shovel, 4-foot level, dead-blow hammer, 2- or 3-pound hammer, chisel, hand tamper, hydraulic splitter and string line. Power tools may include a circular saw with a diamond blade and a plate compactor.
- Always wear protective eye wear.

For additional wall installation references go to Belgard.com.



BASIC INSTALLATION CONSTRUCTION GUIDE - RETAINING WALL

STAKE OUT THE WALL

- Have a surveyor stake out the wall's placement. Verify the locations with the project supervisor.

EXCAVATION

- Excavate for the leveling pad according to the lines and grades shown on the approved plans and excavate enough soil behind the wall for the geogrids material, if needed.
- The trench for the leveling pad should be at least 12 inches wider than the block you are installing and 6 inches below the bottom of the block. *See Diagram 1.*

LEVELING PAD

- An aggregate leveling pad is made of compactable base material of $\frac{3}{4}$ -inch minus (with fines).
- The pad must extend at least 6 inches in front of and behind the first course of block and be at least 6 inches deep after compaction.
- If the planned grade along the wall front will change elevation, the leveling pad may be stepped up in increments of the block height to match the grade change. Start at the lowest level and work upward whenever possible.
- Compact the aggregate and make sure it's level front to back and side to side. *See Diagram 2.*

BASE COURSE

- This is the most important step in the installation process. Bury the base course of block a minimum of 6 inches or as shown on the plans.
- Begin laying block at the lowest elevation of the wall. Remove the rear lip (if applicable) of the block by hitting from the back so that it will lie flat on the leveling pad. *See Diagram 3.*
- Place first block and level, front to back and side to side; lay subsequent blocks in the same manner.
- Place the blocks side by side, flush against each other, and make sure they are in full contact with the leveling pad.
- If the wall is on an incline, don't slope the blocks; step them up so they remain consistently level.
- Use string line along the back edge of block to check for proper alignment.
- For multi-piece products, use the largest unit, 18 inches wide, for the base course.
- Fill cores (if applicable) and voids between blocks with $\frac{3}{4}$ -inch free-draining aggregate prior to laying the next course of block. Clean any debris off the top of the blocks. *See Diagram 4.*
- Install any location devices, such as pins, prior to placing the second course of blocks."
- Install any location devices, such as pins, prior to placing the second course of blocks."



Diagram 1 – Excavation

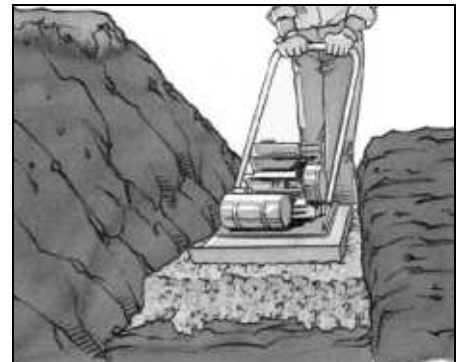

Diagram 2 – Leveling Pad



Diagram 3 – Base Course

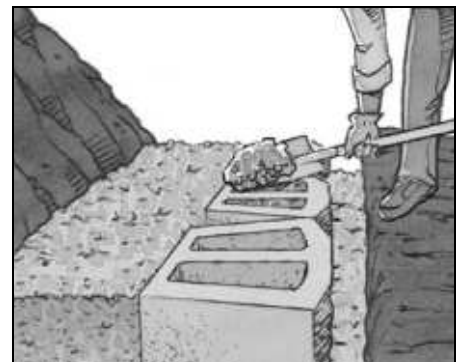

Diagram 4 – Core Fill

CONSTRUCTION OF SUBSEQUENT COURSES

- Clean any debris off the top of the blocks.
- Place the second course of blocks on top of the base course. Maintain running bond. Pull each block forward as far as possible to ensure the correct setback. *See Diagram 5.*
- Fill cores (if applicable) and voids between blocks with $\frac{3}{4}$ -inch free-draining aggregate prior to laying the next course of block. Clean any debris off the top of the blocks.
- Backfill with $\frac{3}{4}$ -inch free-draining aggregate directly behind the block, adding 6 inches at a time followed by proper compaction. Fill thickness will be dependent on compaction equipment
- Add retained soil behind the aggregate. Compact before the next course is laid.
- Don't drive heavy equipment near the wall. Self-propelled compaction equipment should not be used within 3 feet from the back of the wall
- Keep the wall bond by placing units in a staggered relationship to the course beneath.
- You may need partial units to stay on bond. A saw with a diamond blade is recommended for cutting partial units. Use safety glasses and other protective equipment when cutting.

DRAINAGE DESIGN

- Each project is unique. The grades on your site will determine at what level to install the drainpipe.
- Place the drainpipe as low as possible behind the wall so water drains down and away from the wall into a storm drain or to an area lower than the wall. *See Diagram 6.*
- Fill in the area behind the blocks with $\frac{3}{4}$ -inch free-draining aggregate, at a minimum of 12-inches from behind the back of the block or 24-inches from the front of the block, whichever is greater.
- You may need to place and backfill several courses to achieve the proper drainage level. *See Diagrams 7 and 8.*
- The drainpipe outlets should be spaced not more than every 50 feet and at low points of the wall. In order for the gravel fill to function properly, it must keep clear of regular soil fill. See below diagram of daylight drainage system.



Diagram 5 – Next Course Construction

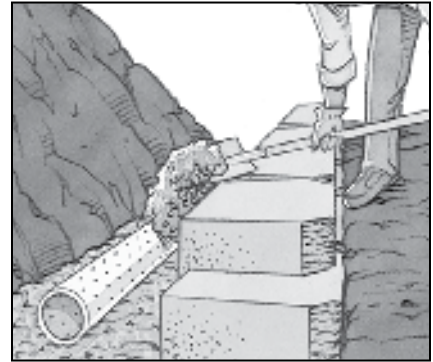

Diagram 6 – Drainage

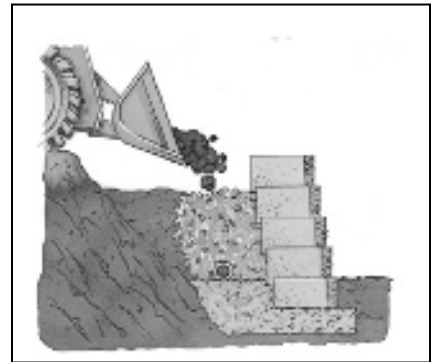

Diagram 7 – Backfill

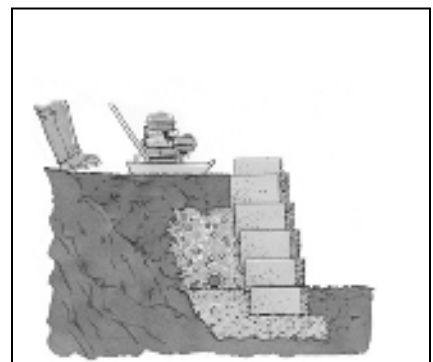
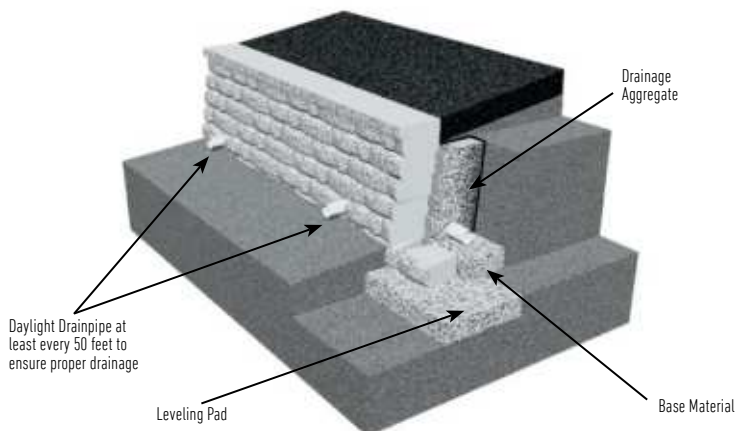

Diagram 8 – Compaction



STEPPING UP THE BASE AT LOWEST POINT

Walls built on a sloping grade require a stepped base. Begin excavation at the lowest point and dig a level trench into the slope until it is deep enough to accommodate the base material and the height of two entire blocks. A minimum embedment of 6 inches is required at all times.

STEP-UP

At this point, step up the height of one block and begin a new section of base trench. Continue to step up as needed to top of slope. Always bury at least one full unit at each step, maintaining a minimum embedment of 6 inches at all times.

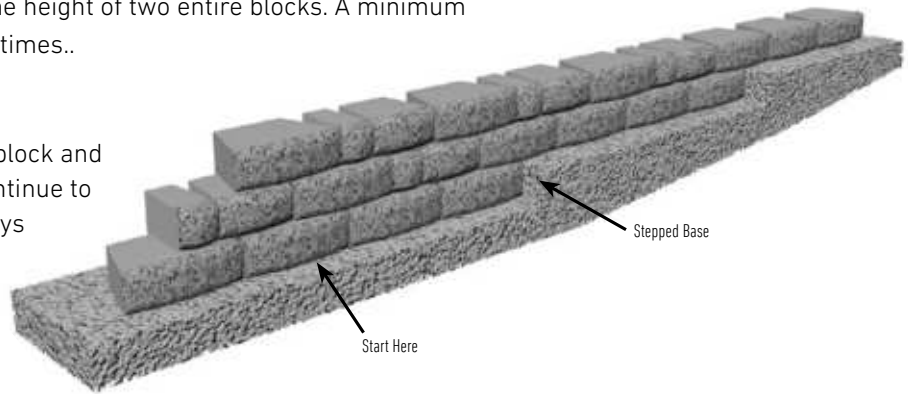

STEPPING UP THE BASE USING THE U START BASE BLOCK

Walls built on a sloping grade require a stepped base. Begin excavation at the lowest point and dig a level trench, 24 inches wide, into the slope until it is deep enough to accommodate the base material, the base block and enough depth to maintain a minimum of 6 inches of embedment after stepping up.

See Diagram 9.



Diagram 9 – Drainage

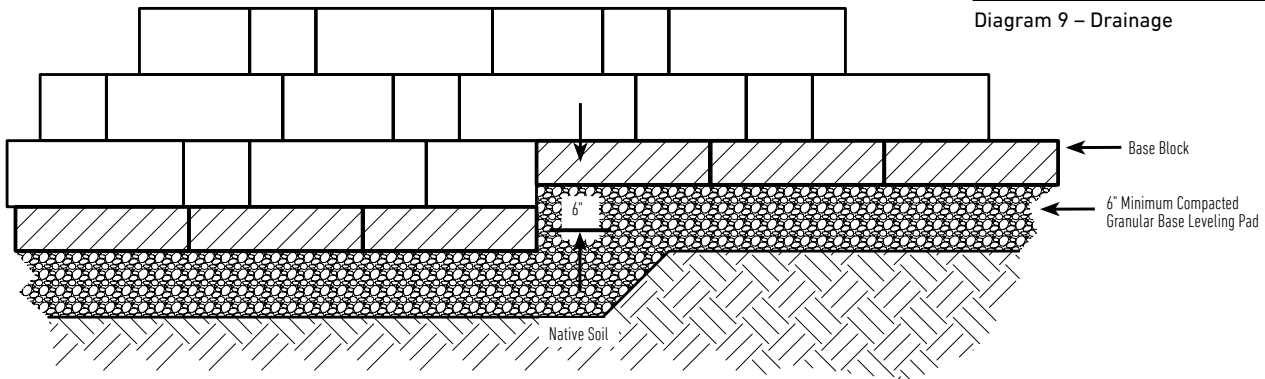

XL™ CAP

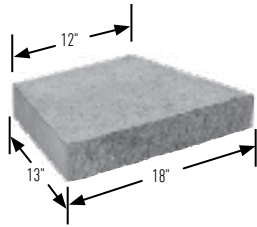

STRAIGHT WALL

The XL™ cap must be laid alternately, short and long faces for a straight line. Always start capping from the lowest elevation. Once caps are aligned, caps should be glued in place using a concrete adhesive.

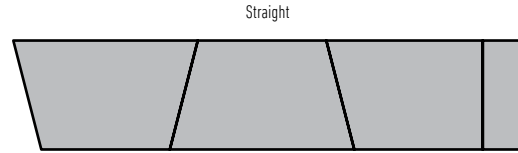

CURVES

Lay out the cap units side by side with the same face facing out (long faces for outside curves; short face to inside curves). If there's a need to adjust for project's radius, make cuts at least every other cap as needed for the most pleasing aesthetic.

- Minimum radius with XL™ cap: 2 feet 2 inches

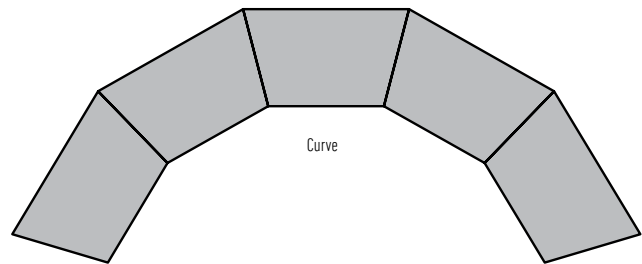

90-DEGREE CORNERS

Saw-cut two caps to achieve a 45-degree mitered corner.

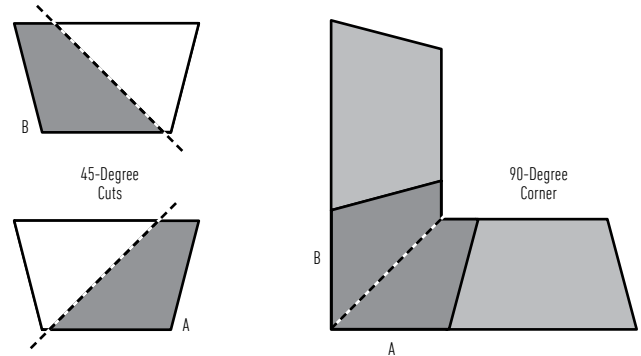

STEPPING UP CAPS WITH XL™ CAP

If the wall elevation changes, caps can be stacked where the wall steps up. Begin laying caps at the lowest elevation change and work your way toward the next step up. Split* a cap unit to fit. Place the split unit directly on top of the capped portion of the wall with all three split faces exposed.

FINISHING WITH XL™ CAP

After layout is complete and caps are saw-cut or split to size, carefully place concrete adhesive on wall top course and then place caps.

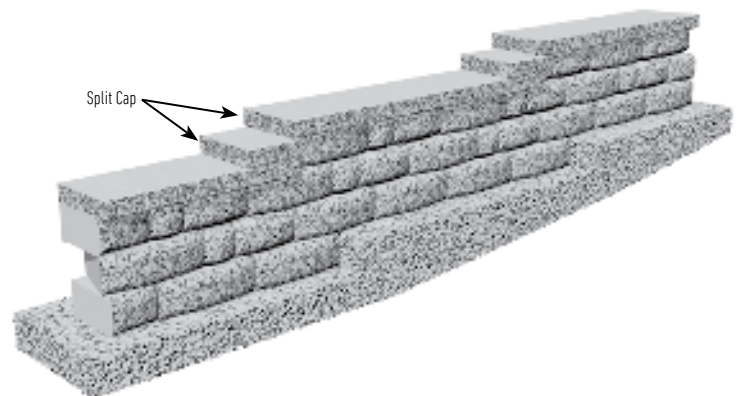

***NOTE:** To split a block, use a hydraulic splitter or split manually by using a hammer and chisel to score the block on all sides. Pound the chisel on the same line until the block splits. If partial unit sides are not exposed, use a saw with a diamond blade to achieve a tighter fit.

GEOSYNTHETIC REINFORCEMENT (IF REQUIRED)

- Geosynthetic reinforcement is recommended for walls taller than the gravity height determined for the project, or walls situated in poor soils, supporting a driveway, etc. Consult an engineer for design assistance.
- Check the wall construction plan for which courses will need geogrids.
- Clean any debris off the top layer of blocks.
- Measure and cut the geogrids to the design length in the plans.
- Many geosynthetic reinforcements have a design strength direction, which must be laid perpendicular to the wall.
- Place the front edge of the geogrids on top of the block, making sure it's within 1 inch of the face of the block. Correct placement ensures that you maximize the connection strength and keep the batter consistent.
- Apply the next course of blocks to secure it in place.
- A minimum of 6 inches of backfill is required prior to operating vehicles on the geogrids. Avoid sudden turning or braking.

COMPACTION

- Place the backfill soil behind the drainage aggregate and compact to 95% standard PROCTOR density with a hand-operated compactor.
- Make sure the aggregate is level with or slightly below the top of the course.
- Place soil in front of the base course and compact. The base course should be buried.
- Continue to fill and compact.

FINISH GRADE AND SURFACE DRAINAGE

- Protect the wall with a finished grade at the top and bottom.
- To ensure proper water drainage away from the wall, use 8 inches of soil with low permeability. This will minimize water seeping into the soil and gravel fill behind the wall. *See Drainage Swales.*

SITE CLEANING AND RESTORATION

- Brush off the wall and pick up any debris left from the construction process.
- Notify the job superintendent in writing of the project's completion and that it is ready for final inspection and acceptance.
- Planting vegetation in front and on top of the wall will help reduce the chance of erosion.
- Following the best practices for construction will ensure the successful installation of Anchor™ products.

DRAINAGE SWALES

- Design and performance of most retaining walls are based on keeping the reinforced zone relatively dry. Appropriate drainage swales to help control water should be designed into the wall construction plan.

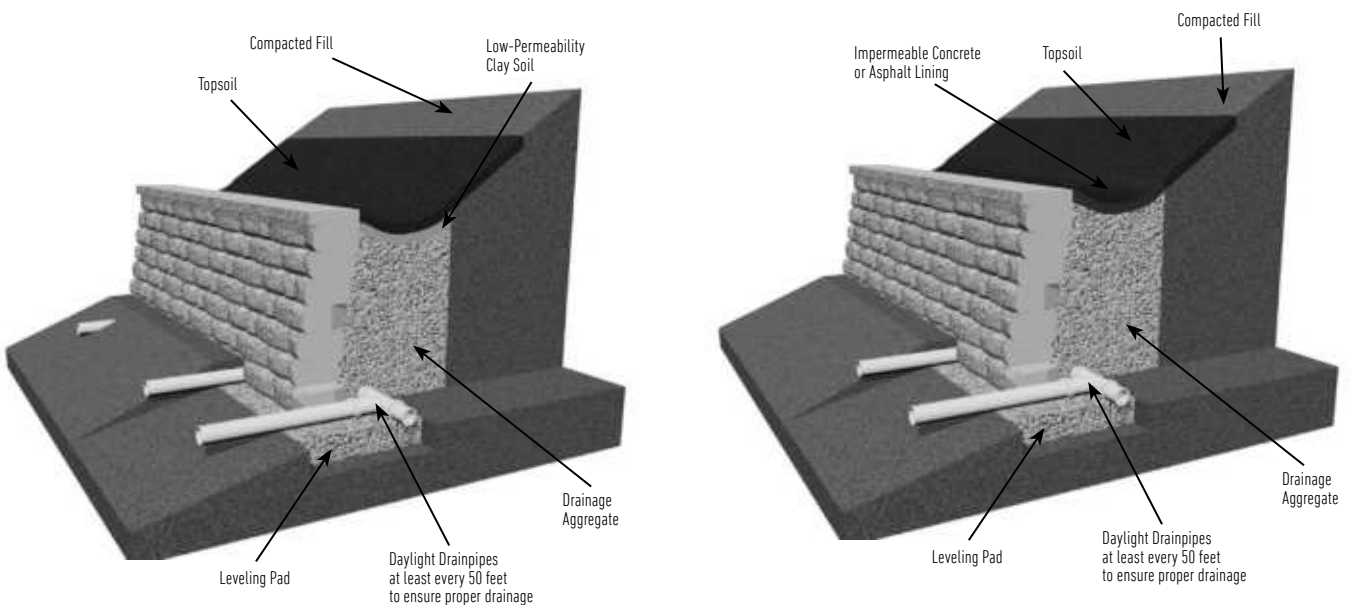

SAFETY NOTE: Always use appropriate equipment, including safety glasses or goggles and respirators, when splitting, cutting or hammering units. Refer to the NCMA Segmental Retaining Wall Installation Guide at www.ncma.org.

ABUTTING AN EXISTING STRUCTURE

FIRST COURSE

Begin with the first block next to the wall and place the first course. Place filter fabric behind the first two units and extend it 2 feet along the existing structure.

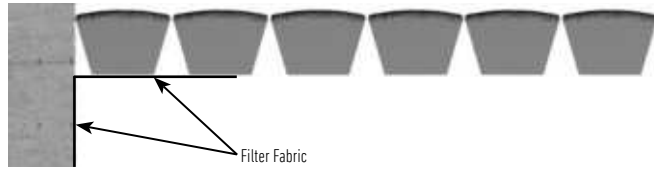

First Course

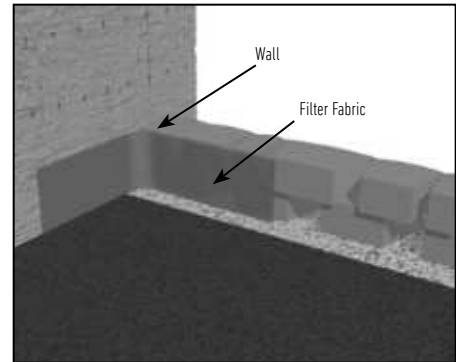
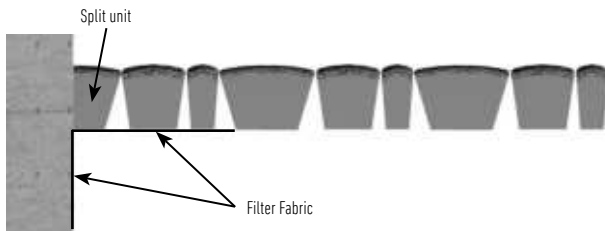

Diagram 10 – Extend Filter Fabric

SECOND COURSE

Build second course with standard installation techniques. A split unit is shown but may not be necessary in every installation. Extend filter fabric to the top edge of the final course. *See Diagram 10.* A rubber membrane may be placed between the units and a non-concrete wall to prevent moisture damage to the structure.



Second Course

Note: To split a block, use a hydraulic splitter or split manually by using a hammer and chisel to score the block on all sides. Pound the chisel on the same line until the block splits. If partial unit sides are not exposed, use a saw with a diamond blade to achieve a tighter fit.

OUTSIDE CURVES

CALCULATE THE RADIUS

When building an outside curve, begin by determining the desired radius of the top course. This will be the smallest radius in the wall and must not be less than the minimum radius for the wall system used.

To determine the approximate base course radius:

- 1) Add ¼-inch to the setback of the block used. Multiply that by the number of courses in the finished wall.
- 2) Add desired radius length of the top course to the result of step 1. This number equals the approximate radius length of the base course.
- 3) To determine the radius for the front edge of the trench, add 6 inches to the approximate radius length of the base course.

Example: Setback of the Highland Stone® product is 1⅛-inch. The wall is 8 courses high. The desired radius of the wall measured to the front of the block on the top course is 6 feet.

- 1) Setback multiplied by number of courses
 $1\frac{1}{8}'' + \frac{1}{4}'' = 1\frac{3}{8}'' \times 8 \text{ courses} = 11''$
- 2) Desired radius plus setback
 $6' + 11'' = 6'11''$
- 3) Front of trench
 $6'11'' + 6'' = 7'5''$

TIP: Subtract the depth of the block if you prefer to mark the curve from the back of the block.

LAY OUT THE TRENCH

Drive a stake into the ground at the desired radius point of the curve. Attach a string and rotate it in an arc at the desired length to mark the curve in the soil. Dig the trench.

BASE COURSE

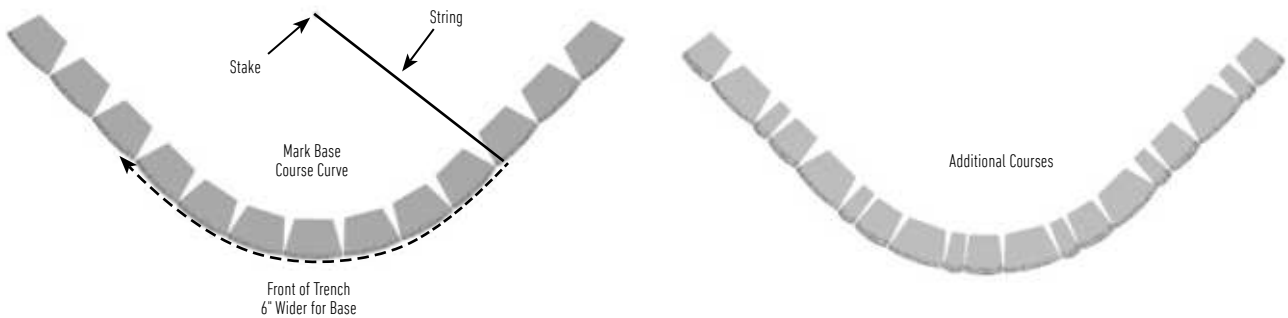

Using the existing radius point stake and string, mark the base course curve on the leveling pad. Align the front of the block with the marked curve and ensure level placement from side to side and front to back.

ADDITIONAL COURSES

On each course, some of the rear lip of each block must be in contact with the back of the units below to ensure structural stability. The setback of the block will cause the radius of each course to gradually decrease and eventually affect the running bond of the wall. To maintain proper running bond, use partial units as needed. Once a split or cut unit is cut to size, glue in place with a concrete adhesive.

INSIDE CURVES

CALCULATE THE RADIUS

Check the wall plan to determine the radius of the top course. This will be the biggest radius in the wall and you will need it to determine the radius at the base course, which will be the smallest radius of the wall and must not be less than the minimum for the block system used.

A QUICK WAY TO DETERMINE THE BASE COURSE RADIUS:

- 1) Add ¼-inch to the setback of the block used. Multiply that by the number of courses in the finished wall.
- 2) Subtract the result of step 1 from the radius of the top course. This number equals the approximate radius length of the base course.
- 3) To determine the radius for the front edge of the trench, subtract 6 inches from the approximate radius length of the base course.

Example: The setback of the Highland Stone® product is 1⅛-inches. The wall is 8 courses high. The desired radius of the wall measured to the front of the block on the top course is 10 feet.

- 1) Setback multiplied by number of courses
 $1\frac{1}{8}'' + \frac{1}{4}'' = 1\frac{3}{8}'' \times 8 \text{ courses} = 11''$
- 2) Desired radius minus setback
 $10' - 11'' = 9'1''$
- 3) Front of trench
 $9'1'' - 6'' = 8'7''$

TIP: Add the depth of the block if you prefer to mark the curve from the back of the block.

LAY OUT THE TRENCH

Drive a stake into the ground at the desired radius point of the curve. Attach a string and rotate it in an arc at the desired length to mark the curve in the soil. Dig the trench.

BASE COURSE

Using existing radius point stake and string, mark the base course curve on the leveling pad. Align the front of the block with the marked curve and ensure level placement from side to side and front to back.

ADDITIONAL COURSES

On each course, some of the lips of each block must be in contact with the back of the units below to ensure structural stability. If not, use construction adhesive to adhere blocks together. To maintain proper running bond, use partial units as needed. Once a split unit is cut to size, glue in place with a concrete adhesive.

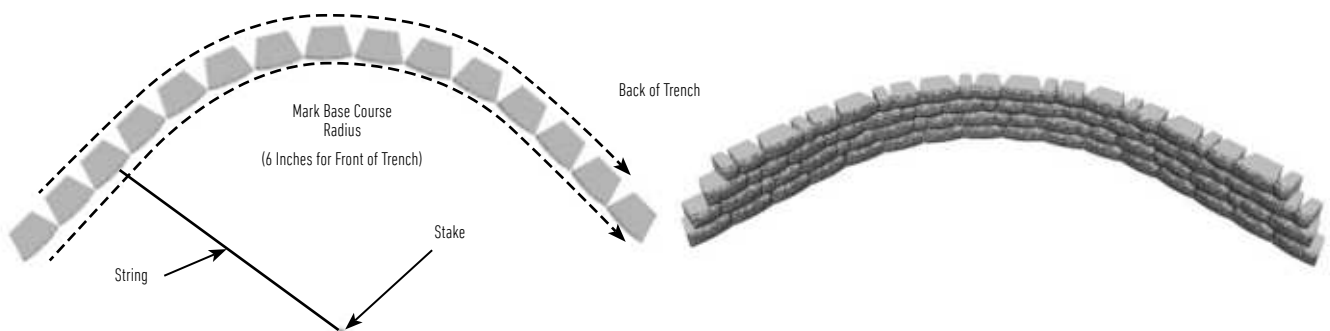

OUTSIDE 90-DEGREE CORNERS

FOR SYSTEMS WITHOUT A CORNER UNIT

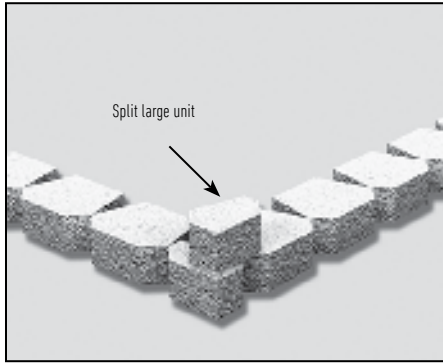

Outside 90-Degree Corner without Corner Unit

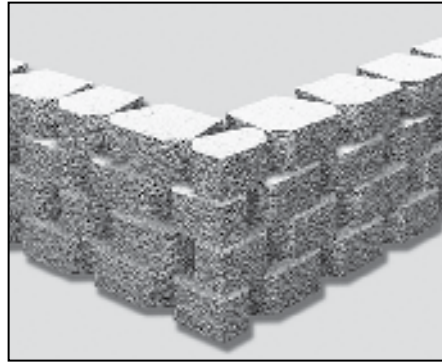

Additional Courses

BASE COURSE

To build an outside 90-degree corner, begin by splitting a unit in half. Place this unit with both split faces out at the corner. If needed, remove the rear lip so that the block lies flat. Then lay the rest of the base course working from the corner block out.

ADDITIONAL COURSES

Begin the next course with the other half of the split unit faced in the opposite direction at the corner. Place the second and third blocks on either side of the corner unit. Once the corner unit is in position, glue block in place with a concrete adhesive. Continue to alternate the corner unit orientation with each course and always use a concrete adhesive on the corner units. Use cut or split units as necessary to maintain running bond.

OUTSIDE 90-DEGREE CORNERS

FOR SYSTEMS WITHOUT A CORNER UNIT

90-degree corners are built by alternating corner/column units so the long side is on different sides of the wall. Build the pattern from the corner unit when possible. Install corner units level from front to back.

Depending on the wall layout, there may be a need to go off the pattern and randomly place wall blocks near the corner. Set back corner units to reflect the batter of the wall block units and glue from bottom to top.



Outside 90-Degree Corner with Corner/Column Unit

NOTE: To split a block, use a hydraulic splitter or split manually by using a hammer and chisel to score the block on all sides. Pound the chisel on the same line until the block splits. If partial unit sides are not exposed, use a saw with a diamond blade to achieve a tighter fit.

INSIDE 90-DEGREE CORNERS

BASE COURSE

To create an inside 90-degree corner, begin by placing a block at the corner. Then lay a second block perpendicular to the first and continue laying out the rest of the base course working from the corner out. Make sure to construct the base course according to standard site prep and installation procedures.



Example Inside 90-Degree Corner

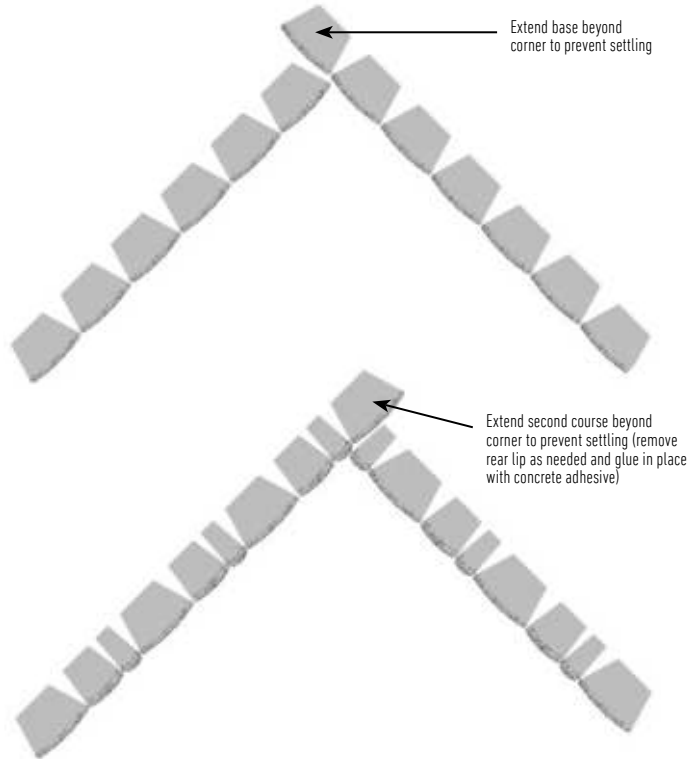

ADDITIONAL COURSES

On the second course, place all blocks on bond along one side of the corner. Once the second course of one wall is established, begin the second course of the adjacent wall. Split units or units of varying sizes may be required on this wall to maintain running bond. Continue to alternate the corner unit orientation with each course and always use a concrete adhesive on the corner units.

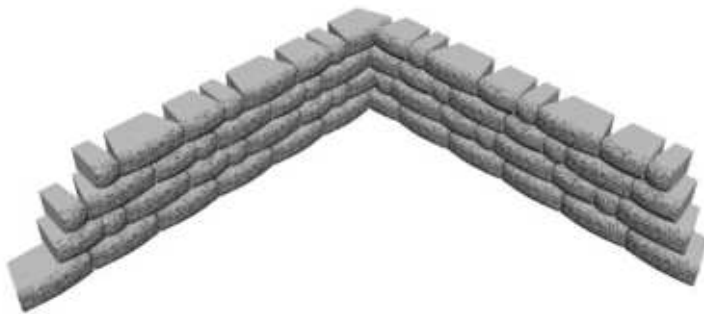

NOTE: To split a block, use a hydraulic splitter or split manually by using a hammer and chisel to score the block on all sides. Pound the chisel on the same line until the block splits. If partial unit sides are not exposed, use a saw with a diamond blade to achieve a tighter fit.

STEPS IN A CURVED WALL

These drawings show Highland Stone®, Diamond® and Diamond Stone Cut® step units. Caps or pavers can be used for treads. Check local building codes for any tread depth standards.



BASE COURSE

Thoroughly compact the leveling pad. Lay out the base course according to the wall design. Place step units first, working from the center to each side. Remember, it is very important to backfill and compact behind and along the sides of each course of step units.

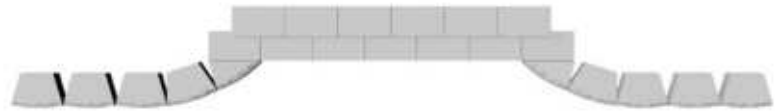

FIRST STEP COURSE

Place the first course of step units directly on top of the base course so there is no setback. Stagger them from the previous course and glue in place.



SECOND STEP COURSE

Add the second course of steps, staggering them from the previous course to maintain running bond. Overlap the lower course by a minimum 2 inches and glue to lower course. Place and compact base material prior to installing next course.



NEXT WALL COURSE

Place a block near the second course of steps, maintaining running bond with the base course. Measure and cut a block to fit the space remaining between the step unit and the next course of the wall. Place the unit in the wall, making sure that both vertical edges fit tight against both the step and standard unit. Remove the rear lip on the blocks when necessary, and angle the blocks flush with the face of the previous course. Glue in place with a concrete adhesive. Repeat these steps until the wall is finished.

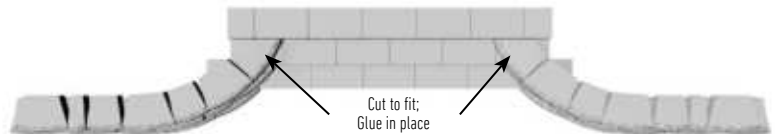

ADDITIONAL COURSES

Beginning in the center, add the third course of steps, lining up the units with the first course. Overlap a minimum 2 inches and glue in place. Repeat until the steps are finished.

DRAINAGE TIP: Drain pipe can be placed behind the lowest step units at grade or behind each wall adjacent to the steps.

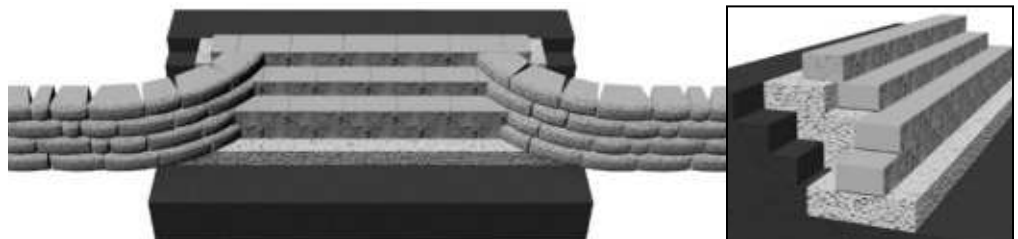

STEPS IN A 90-DEGREE WALL

These drawings show Highland Stone®, Diamond® and Diamond Stone Cut® step units. Caps or pavers can be used for treads. Check local building codes for any tread depth standards.



BASE COURSE

Thoroughly compact the leveling pad. Lay out the base course according to the wall design. Place step units first, working from the center to each side. Remember, it is very important to backfill and compact behind and along the sides of each course of step units.

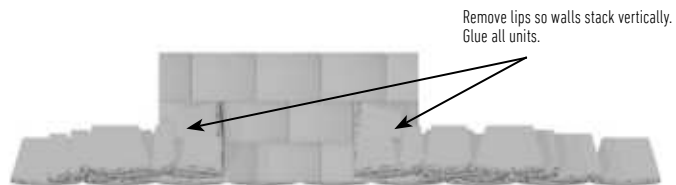

FIRST STEP COURSE

Place the first course of step units directly on top of the base course so there is no setback. Stagger them from the previous course and glue in place.



SECOND STEP COURSE

Add the second course of steps, staggering them from the previous course to maintain running bond. Overlap the lower course by a minimum 2 inches and glue to lower course. Place and compact base material prior to installing next course.

SECOND WALL COURSE

Build the second course of the wall. Corner units are used at the end of steps tied into wall and glued in place. Alternate long and short direction of corner unit every other row.

THIRD STEP COURSE

Beginning in the center, add the third course of steps, lining up the units with the first course. Overlap the lower course by 2 inches and glue to lower course.

ADDITIONAL COURSES

Build the third course of the wall. Repeat these steps until the wall is finished.

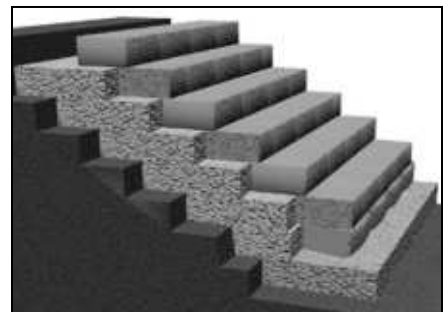
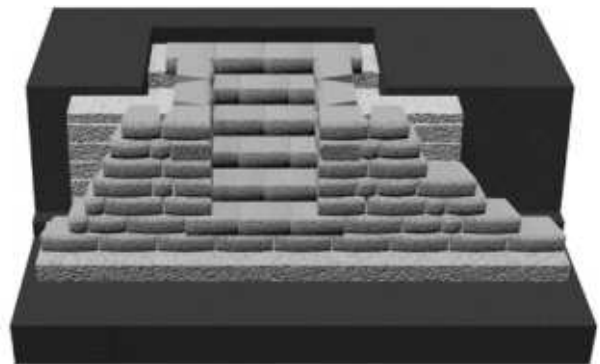

ANCHORPLEX® SYSTEM CONSTRUCTION GUIDE

HOW TO USE THIS GUIDE

Use this information to gain a general understanding of the basics of building retaining walls with the Anchorplex system. Do not use this in lieu of construction drawings provided by a qualified engineer. Contact ANCHOR Diamond® at 1-877-295-5415 for more information about designing and building with the Anchorplex system.

ABOUT THE ANCHORPLEX® SYSTEM

The Anchorplex system is a retaining wall built with Oldcastle™ products and self-compacting structural backfill, also known as “no-fines” concrete, which is a highly-porous mixture of clean stone, cement and water. The mixing ratios (by weight) of aggregate to cementitious material should be between 6:1 and 7:1. The mixing rate (by weight) of water to cementitious material should be no more than 1:2. The resulting material, upon curing, should have at least 25 percent voids.

RETAINING WALL CONSTRUCTION

Setting out the wall and excavation is no different for an Anchorplex system construction than for conventional construction, except that the amount of excavation will probably differ. Construction of the leveling pad, base course, subsequent courses and drainage is no different for an Anchorplex system construction than for conventional construction.

INSTALLATION OF STRUCTURAL BACKFILL

After completion of the leveling pad, base course, drainpipe installation and stacking block 2 feet above grade, the first lift of structural backfill that meets Anchor Wall Systems' specifications can be installed. Do not exceed 2 feet vertical stacking of block before placing a lift of structural backfill

The structural backfill can be placed directly from delivery vehicle or with skid-type loader or other equipment. It should be placed behind the blocks and worked into all voids and cores of the blocks (if applicable). When properly formulated, the structural backfill will not leak through the face of the wall.

After installation of the first lift of structural backfill, install additional courses and repeat the process. Place additional lifts every 8 to 24 inches depending on site conditions and project scale. Subsequent pours can be made as soon as the structural backfill in the previous lift has set — usually within 2 to 3 hours.

INSTALLATION OF FILTER FABRIC

Place a layer of filter fabric over the structural backfill and up the back of the top course and the cap. Then fill behind the top course and cap with low-permeability soil.

CAPPING & FINISHING

Follow standard practice when capping the wall. Protect the wall with a finish grade at the top and bottom.

EXAMPLE: 6" MULTI-PIECE RETAINING WALL SYSTEM USING THE ANCHORPLEX SYSTEM

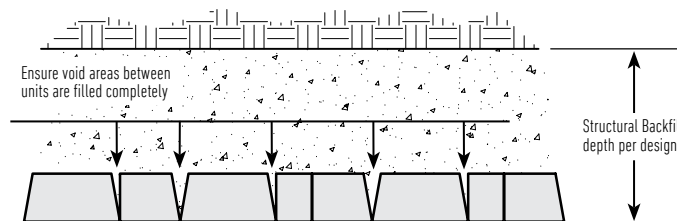
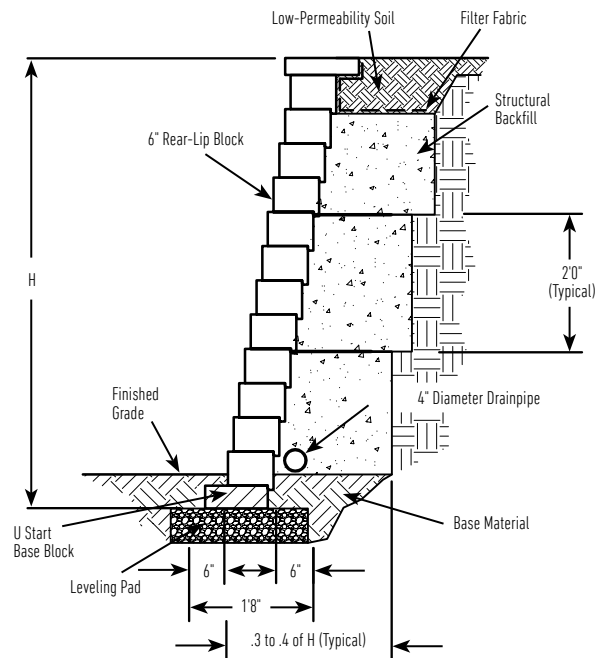

LAYING PATTERN GUIDE FOR MULTI-PIECE WALLS

USING A PATTERN FOR SINGLE-HEIGHT RETAINING WALLS

When using a pattern, begin at one edge, laying the units as indicated. Install at least one repeat of the pattern to establish the pattern before proceeding to the next course. Stagger the patterns as shown to avoid vertical bonds.

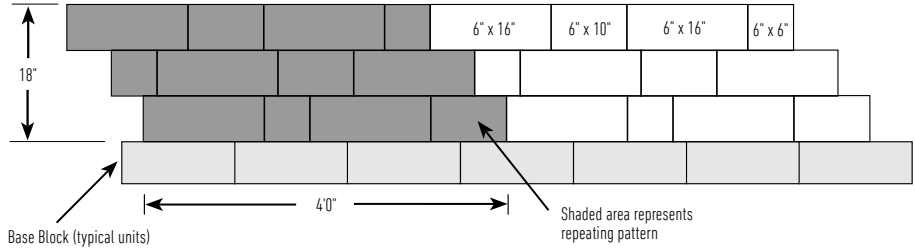

One set of 6-inch-high retaining wall blocks consists of 2 large units, 1 medium unit and 1 small unit, and is 2 square feet.

6" Multipiece wall system, 18-inch by 4-foot pattern = 6 sq. ft.

Blocks required		Blocks required	
12	6" x 16"	6	6" x 16"
6	6" x 10"	3	6" x 10"
6	6" x 6"	3	6" x 6"

USING A PATTERN FOR FREESTANDING WALLS

One set of 6-inch-high blocks consists of 2 large units, 1 medium unit and 1 small unit, and is 1 square foot of two sided wall.

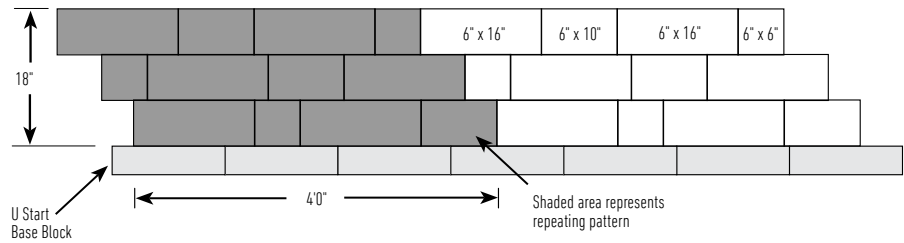

Note: These freestanding wall installation patterns show only one side of the freestanding wall. The same number of blocks are needed to build the other side of a freestanding wall when using Belair Wall 2.0 and Brisa freestanding wall systems. Freestanding wall installation patterns are measured in length by height of one side of the wall, and are expressed in square feet. Sets of blocks required include the number of blocks needed to build both sides of the wall.

ENDING A WALL WITH WALL ENDS

Start pattern next to a wall end unit if the wall does not end with a column. Every other wall end is cut in half. Glue all pieces in place using concrete adhesive.

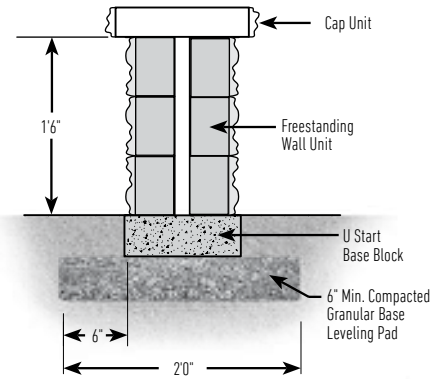

TYPICAL CROSS SECTION

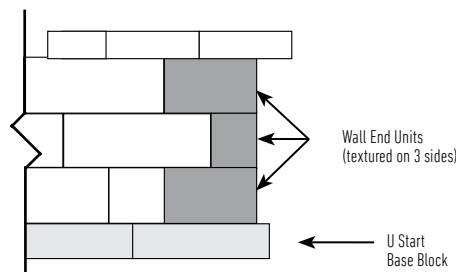

COLUMN CONSTRUCTION

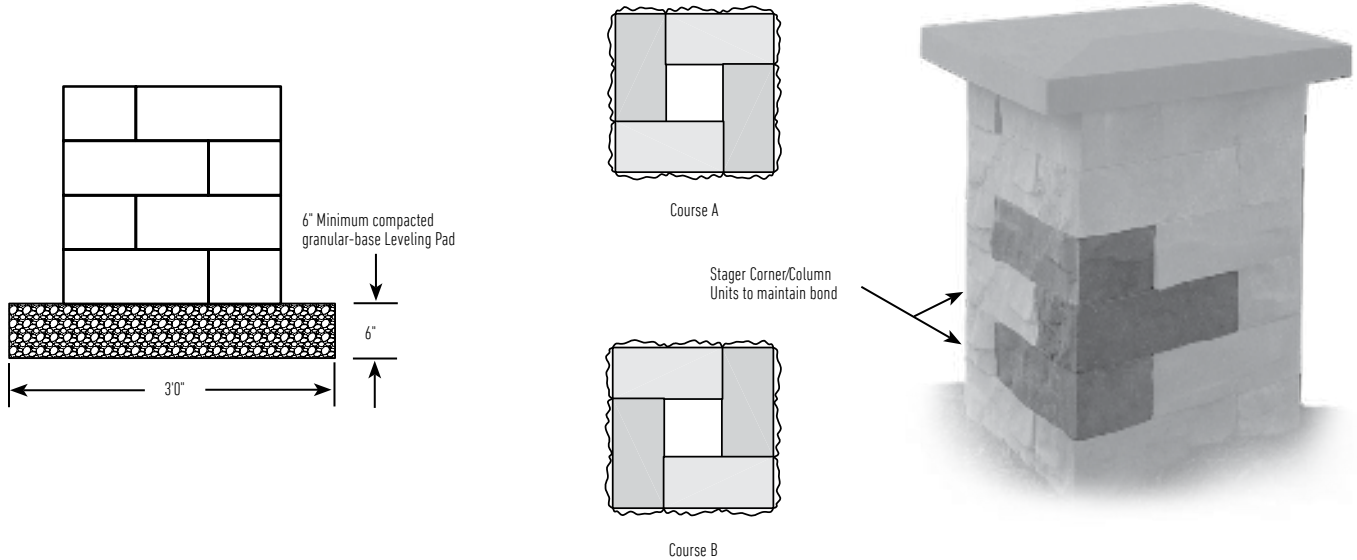

STEPPING UP THE BASE AT LOWEST POINT

Walls built on a sloping grade require a stepped base. Begin excavation at the lowest point and dig a level trench into the slope until it is deep enough to accommodate the base material and height of one entire block.

STEP-UP

At this point, step up the height of one block and begin a new section of base trench. Continue to step up as needed to top of slope. Always bury at least one full unit at each step.

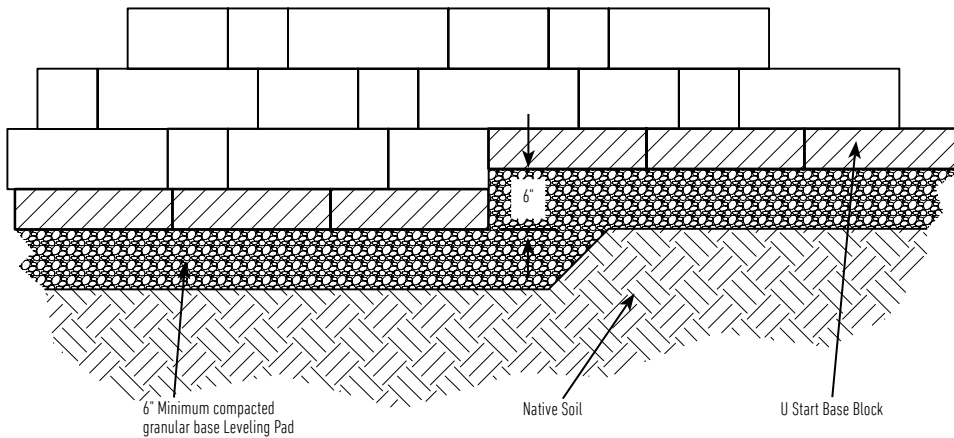

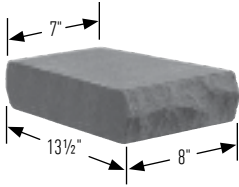

TRAPEZOID DOUBLE-SIDED CAP

The double-sided cap has a right-angle side and an offset-angle side. The caps can be used in any of four directions since there is no specific top or bottom.

STRAIGHT WALL

The cap must be laid alternately, narrow (N) and wide (W) faces, for a straight line. Always start capping from the lowest elevation.

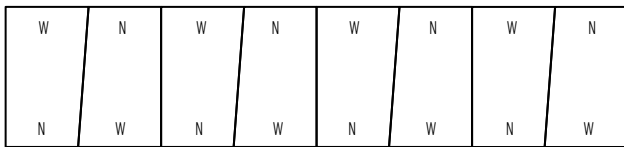

CURVES

Lay out the cap units side by side with same face facing out (wide faces for outside curves; narrow faces for inside curves). Occasional cutting of some pieces may be necessary.

Minimum radius: 7'6"

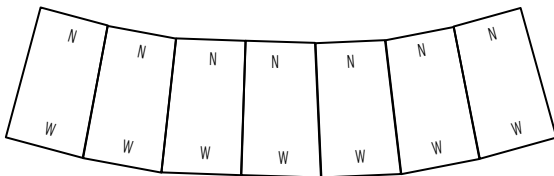

STEPPING UP CAPS WITH CAP ENDS

If a wall elevation changes, caps can be stacked where the wall steps up. Begin laying caps at the lowest elevation and work your way toward the next step-up. Cut a cap unit to fit. Place the cut unit directly on top of the capped portion of the wall with the cut side hidden from view. If not using a Cap End, place the trapezoid double-sided cap so that the side with the arrow is hidden.

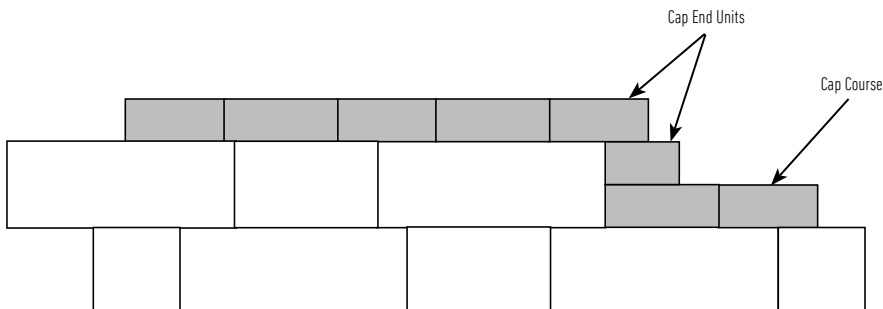

NOTE: To split a block, use a hydraulic splitter or split manually by using a hammer and chisel to score the block on all sides. Pound the chisel on the same line until the block splits. If partial unit sides are not exposed, use a saw with a diamond blade to achieve a tighter fit.

90-DEGREE CORNERS WITH CAP END

Using a Cap End unit.

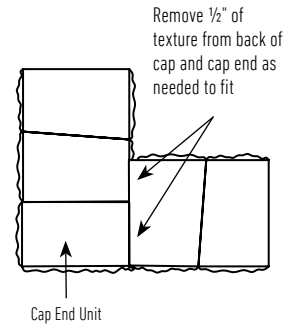
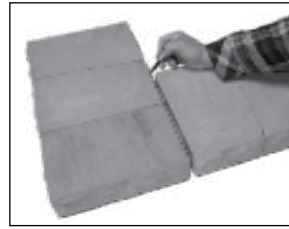

FINISH WITH A CAP END

Do not cut the cap end, cut an interior cap if needed.

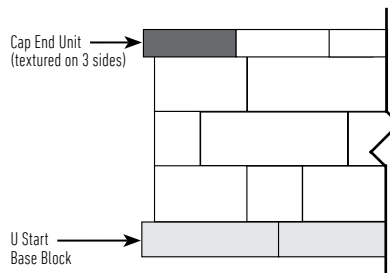

STEP CONSTRUCTION

When constructing steps, you must consider whether it is a fill or a cut-grade situation. Construction is similar, but varies in the amount of dummy units required.

A fill step will have a base course of dummy units in the entire footprint of the steps. For each additional step, add dummy units behind the facing units for stability. There are two methods for creating the step facing. Use sets of either 6-inch-high or 3-inch-high units. A cut-grade set of steps will use one layer of dummy blocks under each step, effectively stepping up the grade.

All applications will require some sort of tread to cover the facing units.

USING FILL SCENARIO

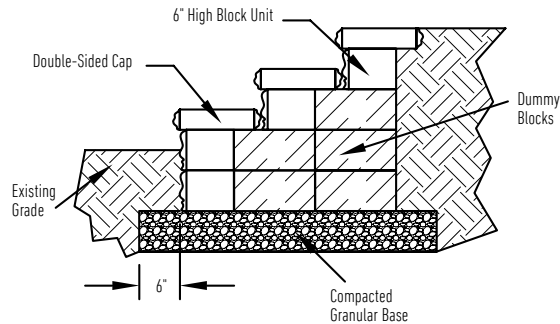

USING CUT SCENARIO

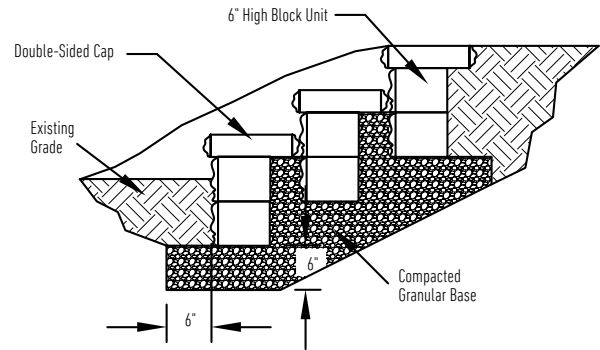

RETAINING WALL SQUARE FIRE PIT CONSTRUCTION

Inside of fire pit must be lined with a heat-resistant material.

Affix all units with construction-grade adhesive.



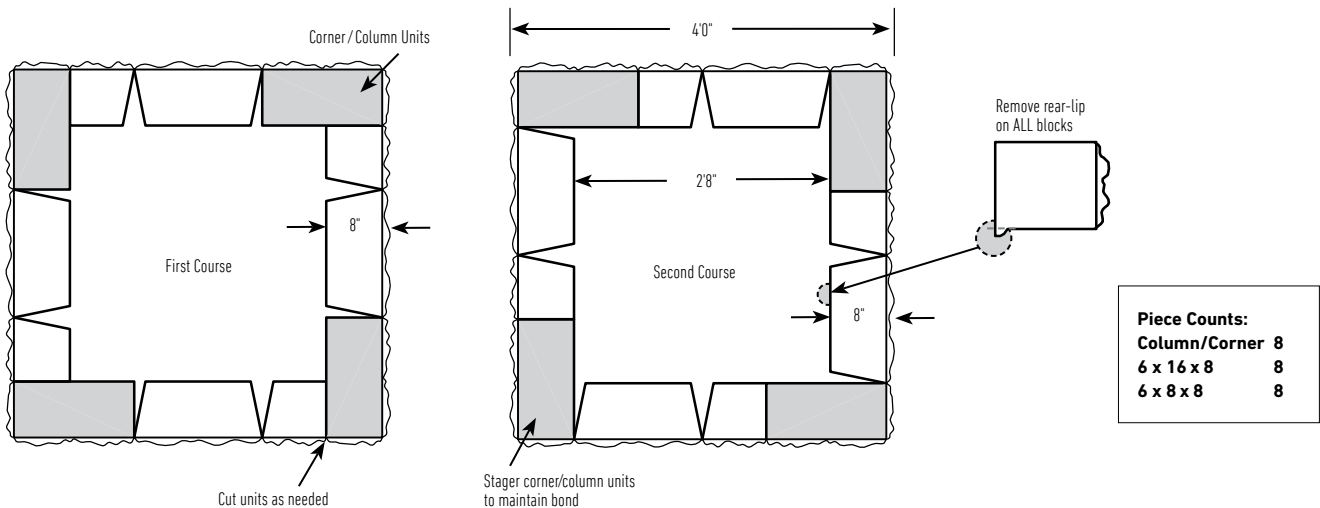
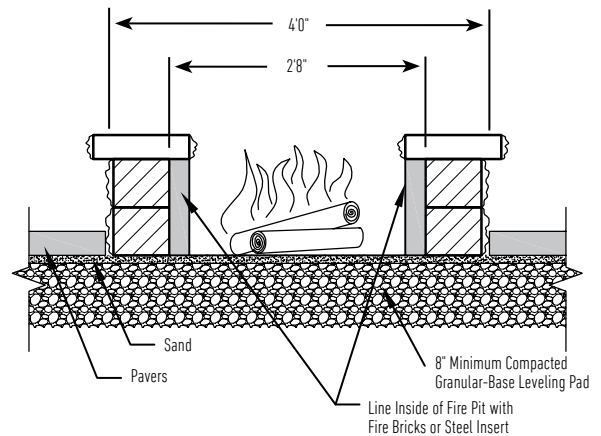





These blocks are not fireproof and could start to crack under extreme heat. These blocks are intended for landscape applications and are not fire-rated. Over time the blocks may crack. A possible solution is to use heavy fire-rated bricks or a steel liner on the interior of an above or below ground fire ring/pit with the blocks outside the perimeter. Again, the heat may adversely affect landscape products, even with an interior heat-resistant barrier in place.





Scan for additional
product information

NOTE: For walls over 30 inches in height, soil reinforcement is generally necessary.
A qualified engineer should be consulted for design and analysis of structures.

RESIDENTIAL	COMMERCIAL	STEPS	COLUMNS	FIRE PITS	KITCHEN	FREESTANDING WALL	RETAINING WALL
							
✓	✓	✓	✓	✓	✓	✓	✓

SHAPES & SIZES

3-Piece



7 x 13³/₁₆ x 2⁵/₈ 7 x 15¹³/₁₆ x 2⁵/₈ 7 x 18⁷/₁₆ x 2⁵/₈

Cap



15 x 24 x 3¹/₄

Modular Block



7¹/₁₆ x 7⁷/₈ x 7⁷/₈
(Connectors included)

U Start Base Block



12 x 18⁷/₁₆ x 3¹/₂
(Recommended for all installations)

UNIT	SQFT/ PALLET	SQFT/ LAYER	LAYER/ PALLET	UNITS/ PALLET	UNITS/ SQFT	WEIGHT/ UNIT	WEIGHT/ PALLET
------	-----------------	----------------	------------------	------------------	----------------	-----------------	-------------------

3-PIECE

7 X 13 ³ / ₁₆ X 2 ⁵ / ₈	19.2	3.2	–	30	1.56	18.23	546.82
7 X 15 ¹³ / ₁₆ X 2 ⁵ / ₈	23.55	3.92	–	30	1.27	22.36	671
7 X 18 ⁷ / ₁₆ X 2 ⁵ / ₈	27.35	4.56	–	30	1.09	26.04	781.48
TOTAL	70.1	11.68	6	90	–	–	2003

CAP

15 X 24 X 3 ¹ / ₄	64 LF	8 LF	8	32	0.5 LF	95.31	3050
---	-------	------	---	----	--------	-------	------

MODULAR BLOCK

7 ¹ / ₁₆ X 7 ⁷ / ₈ X 7 ⁷ / ₈	49.29	–	4	128	0.389	22	2816
--	-------	---	---	-----	-------	----	------

U START BASE BLOCK®

12 X 18 ⁷ / ₁₆ X 3 ¹ / ₂	77.88 LF	11.13 LF	7	56	0.72	54	3080
--	----------	----------	---	----	------	----	------



BELAIR WALL® 2.0

NATURAL
COLLECTION 



Scan for additional
product information

NOTE: For walls over 30 inches in height, soil reinforcement is generally necessary. A qualified engineer should be consulted for design and analysis of structures.

RESIDENTIAL	COMMERCIAL	STEPS	COLUMNS	FIRE PITS	KITCHEN	FREESTANDING WALL	RETAINING WALL
							
✓	✓	✓	✓	✓	✓	✓	✓

SHAPES & SIZES

3-Piece Freestanding Wall



6 x 6 x 5



6 x 10 x 5



6 x 16 x 5



6 x 6 x 8



6 x 10 x 8



6 x 16 x 8

3-Piece Retaining Wall

Corner/Column



7.25 x 16 x 8

Cap



3 x 7 / 8 x 13½

Cap End



3 x 8 x 13½

Wall End



6 x 8 x 11

See pallet information on the following page.





Scan for additional
product information

UNIT	SQFT/ PALLET	SQFT/ LAYER	LAYER/ PALLET	UNITS/ PALLET	UNITS/ SQFT	WEIGHT/ UNIT	WEIGHT/ PALLET
------	-----------------	----------------	------------------	------------------	----------------	-----------------	-------------------

3-PIECE FREESTANDING

6 X 6 X 5	3.75	0.75	–	30	8	11.25	337.5
6 X 10 X 5	6.25	1.25	–	30	4.8	18.75	562.5
6 X 16 X 5	20	4	–	60	3	30	1800
TOTAL	30	6	5	120	–	–	2700

3-PIECE RETAINING

6 X 6 X 8	3.75	1.25	–	15	4	20.4	306
6 X 10 X 8	6.25	2.08	–	15	2.4	34.06	511
6 X 16 X 8	20	6.66	–	30	1.5	54.26	1628
TOTAL	30	10	3	60	–	–	2445

CORNER/COLUMN

7.25 X 16 X 8	18.66	9.33	2	28	1.5	58.92	1650
---------------	-------	------	---	----	-----	-------	------

CAP

3 X 7 / 8 X 13½	90 LF	11.25	8	144	1.6	24.37	3510
-----------------	-------	-------	---	-----	-----	-------	------

CAP END

3 X 8 X 13½	24 LF	12	2	36	1.5	25.33	912
-------------	-------	----	---	----	-----	-------	-----

WALL END

6 x 8 x 11	14	7	2	42	3	43.61	1832
------------	----	---	---	----	---	-------	------



BELAIR WALL® 2.0 - LAYING PATTERN GUIDE

USING A PATTERN FOR SINGLE-HEIGHT RETAINING WALLS

When using a pattern, begin at one edge, laying the units as indicated. Install at least one repeat of the pattern before proceeding to the next course. Stagger the patterns as shown to avoid vertical bonds.

One set of 6-inch-high retaining wall blocks consists of 2 large units, 1 medium unit and 1 small unit, and is 2 square feet.

6" Multipiece wall system, 18-inch by 4-foot pattern = 6 sq. ft.

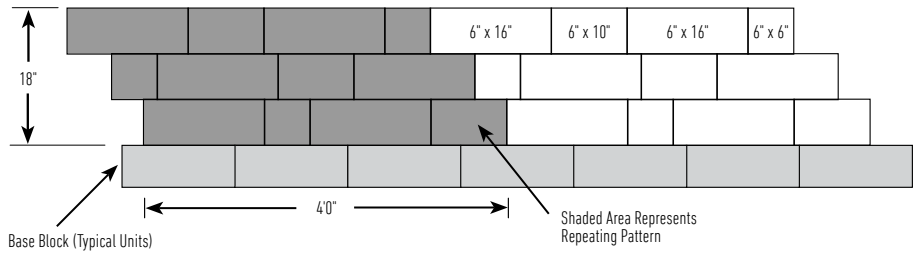

Blocks required		Blocks required	
6 Sets			
12	6" x 16"	6	6" x 16"
6	6" x 10"	3	6" x 10"
6	6" x 6"	3	6" x 6"

WHEN TO USE A PATTERN FOR FREESTANDING WALLS

One set of 6-inch-high blocks consists of 2 large units, 1 medium unit and 1 small unit, and is 1 square foot of two sided wall.

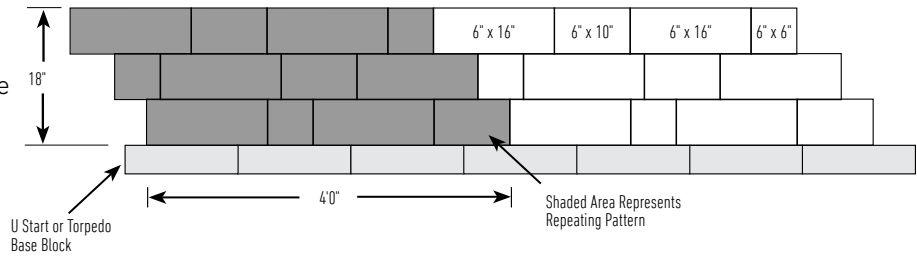

NOTE: These freestanding wall installation patterns show only one side of the freestanding wall. The same number of blocks are needed to build the other side of a freestanding wall when using Belair Wall 2.0 freestanding wall systems. Freestanding wall installation patterns are measured in length by height of one side of the wall, and are expressed in square feet. Sets of blocks required include the number of blocks needed to build both sides of the wall.

TYPICAL CROSS SECTION

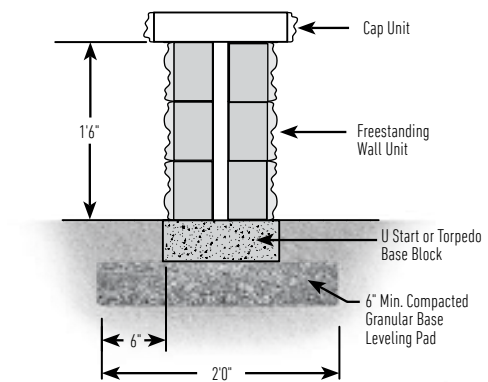

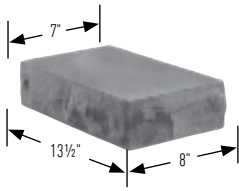

TRAPEZOID DOUBLE-SIDED CAP

The double-sided cap has a right-angle side and an offset-angle side. The caps can be used in any of four directions since there is no specific top or bottom.

STRAIGHT WALL

The cap must be laid alternately, narrow (N) and wide (W) faces, for a straight line. Always start capping from the lowest elevation.

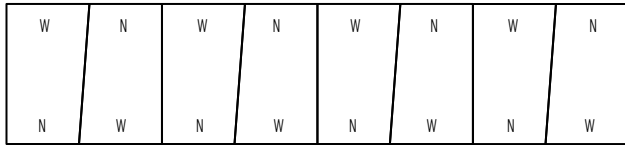

CURVES

Lay out the cap units side by side with same face facing out (wide faces for outside curves; narrow faces for inside curves). Occasional cutting of some pieces may be necessary.

Minimum radius: 7'6"

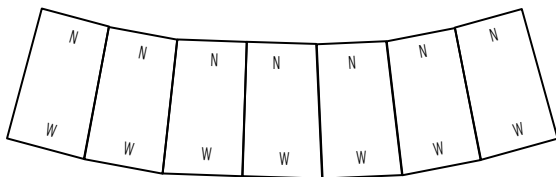

90-DEGREE CORNERS WITH CAP END

Using a Cap End unit

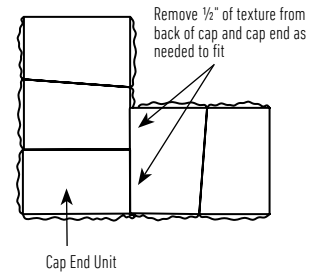
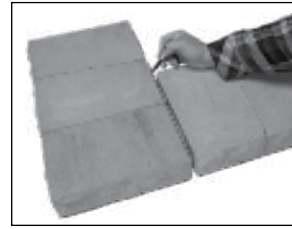

FINISH WITH A CAP END

Do not cut the cap end, cut an interior cap if needed.

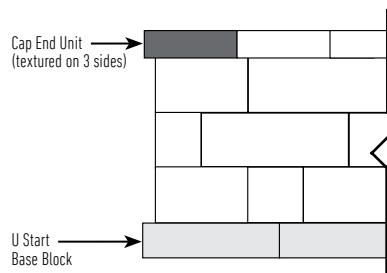

STEPPING UP CAPS WITH CAP ENDS

If a wall elevation changes, caps can be stacked where the wall steps up. Begin laying caps at the lowest elevation and work your way toward the next step-up. Cut a cap unit to fit. Place the cut unit directly on top of the capped portion of the wall with the cut side hidden from view. If not using a Cap End, place the trapezoid double-sided cap so that the side with the arrow is hidden.

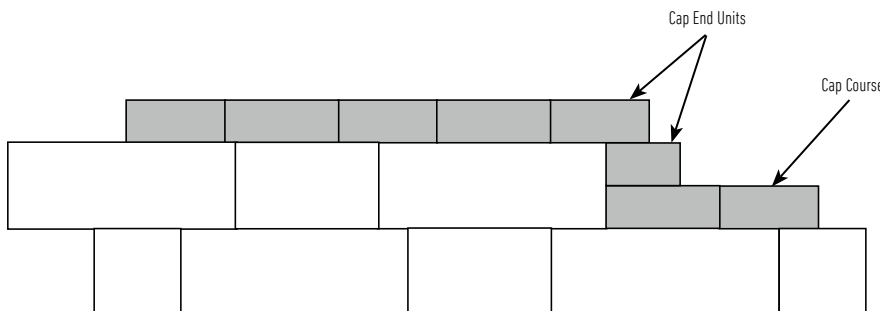









NOTE: To split a block, use a hydraulic splitter or split manually by using a hammer and chisel to score the block on all sides. Pound the chisel on the same line until the block splits. If partial unit sides are not exposed, use a saw with a diamond blade to achieve a tighter fit.



Scan for additional
product information

NOTE: For walls over 30 inches in height, soil reinforcement is generally necessary. A qualified engineer should be consulted for design and analysis of structures.

RESIDENTIAL	COMMERCIAL	STEPS	COLUMNS	FIRE PITS	KITCHEN	FREESTANDING WALL	RETAINING WALL
							
✓		✓	✓	✓	✓	✓	✓

SHAPES & SIZES

Wall Units

Cap



6 x 6 / 4 x 10



6 x 12 / 10 x 10



6 x 16 / 14 x 10



3 x 12 / 8 x 12

UNIT	SQFT/ PALLET	SQFT/ LAYER	LAYER/ PALLET	UNITS/ PALLET	UNITS/ SQFT	WEIGHT/ UNIT	WEIGHT/ PALLET
------	-----------------	----------------	------------------	------------------	----------------	-----------------	-------------------

WALL UNITS

6 X 6 / 4 X 10	4.16	0.83	–	20	4.8	22	440
6 X 12 / 10 X 10	9.16	1.83	–	20	2.18	48	960
6 X 16 / 14 X 10	12.5	2.5	–	20	1.6	66	1320
TOTAL	26	5.16	5	60	–	–	2720

CAP

3 X 12 / 8 X 12	60 LF	10 LF	6	72	1.2 LF	28.32	2039
-----------------	-------	-------	---	----	--------	-------	------



CASTLEMANOR - LAYING PATTERN GUIDE FOR MULTI HEIGHT RETAINING WALLS

WHEN TO USE A PATTERN

You can install the multipiece retaining wall system in a random pattern using any combination of units. Just avoid vertical lines that span more than 1 foot in height. If you are building a wall without geosynthetic reinforcement, use a pattern for inspiration or follow the pattern exactly. Pleasing random patterns can be built using an equal number of 6- and 3-inch high blocks or using an equal square footage of blocks in each size. These patterns are based on using an equal number of blocks of each size in each height.

When building a wall that includes geosynthetic reinforcement, using a pattern at the appropriate spacing eliminates the need to cut the geogrid. When using a pattern, begin at one edge laying the blocks as indicated. Install at least one repeat of the pattern to establish the pattern before proceeding to the next course.

SEQUENT™ PANEL INSTALLATION PATTERN



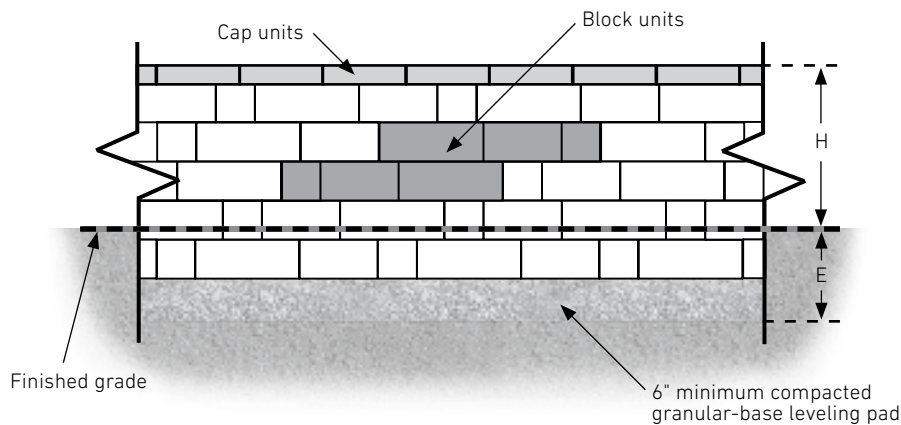





9-inch by 5-foot 8-inch Installation Pattern. This 9-inch high by 34-inch long installation pattern uses an equal number of units of each face size to make the panel. This installation pattern is one of many possible options. Others can be used for different appearances.





Scan for additional
product information

NOTE: For walls over 30 inches in height, soil reinforcement is generally necessary.
A qualified engineer should be consulted for design and analysis of structures.

RESIDENTIAL	COMMERCIAL	STEPS	COLUMNS	FIRE PITS	KITCHEN	FREESTANDING WALL	RETAINING WALL
							
✓	✓	✓					✓

SHAPES & SIZES

Block

Cap



6 x 17¾ x 9



3 x 18 / 12 x 13

UNIT	SQFT/ PALLET	SQFT/ LAYER	LAYER/ PALLET	UNITS/ PALLET	UNITS/ LAYER	UNIT/ SQFT	WEIGHT/ PALLET
BLOCK							
6 X 17¾ X 9	35.5	8.875	4	48	12	1.35	2670
CAP							
3 X 18 / 12 X 13	78.75 LF	11.25 LF	7	63	9	1.25 LF	3700











DIAMOND PRO® STRAIGHT FACE



Scan for additional product information

NOTE: For walls over 30 inches in height, soil reinforcement is generally necessary. A qualified engineer should be consulted for design and analysis of structures.

RESIDENTIAL	COMMERCIAL	STEPS	COLUMNS	FIRE PITS	KITCHEN	FREESTANDING WALL	RETAINING WALL
							
✓	✓						✓

SHAPES & SIZES

Block

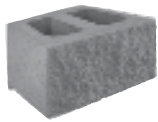

8 x 18 x 12

4" Cap



4 x 18 x 13

8" Cap



8 x 18 x 13

UNIT	SQFT/ PALLET	SQFT/ LAYER	LAYER/ PALLET	UNITS/ PALLET	UNITS/ LAYER	UNIT/ SQFT	WEIGHT/ PALLET
BLOCK							
8 X 18 X 12	45	9	5	45	9	1	3548
4" CAP							
4 X 18 X 13	96 LF	12 LF	8	64	8	–	4155
8" CAP							
8 X 18 X 13	90 LF	12 LF	5	40	8	–	4120





Scan for additional
product information

NOTE: For walls over 30 inches in height, soil reinforcement is generally necessary. A qualified engineer should be consulted for design and analysis of structures.

RESIDENTIAL	COMMERCIAL	STEPS	COLUMNS	FIRE PITS	KITCHEN	FREESTANDING WALL	RETAINING WALL
✓	✓	✓	✓			✓	✓

SHAPES & SIZES

2-Piece 6" FSW



6 x 6 / 4 x 9

18" FSW



6 x 18 / 16 x 9

2-Piece 6" SRW



6 x 6 x 12



6 x 12 x 12

18" SRW



6 x 18 x 12

Corner/Column



6 x 18 x 9

Cap



3 x 18 / 12 x 13

See pallet information on the following page.





Scan for additional
product information

UNIT	SQFT/ PALLET	SQFT/ LAYER	LAYER/ PALLET	UNITS/ PALLET	UNITS/ SQFT	WEIGHT/ UNIT	WEIGHT/ PALLET
2-PIECE 6" FREESTANDING WALL							
6 X 6 / 4 X 9	10.67	2.67	–	48	4.49	23.2	1113.75
6 X 12 / 10 X 9	21.33	5.33	–	48	2.25	47.1	2261.25
TOTAL	32	8	4	96	-	-	3375
18" FREESTANDING WALL							
6 X 18 / 16 X 8	27	9	3	36	1.33	82.22	2960
2-PIECE 6" SEGMENTAL RETAINING WALL							
6 X 6 X 12	9	2.25	–	36	4	26.58	957
6 X 12 X 12	18	4.5	–	36	2	53.97	1943
TOTAL	27	6.75	4	72	-	-	2900
18" SEGMENTAL RETAINING WALL							
6 X 18 X 12	27	6.75	4	36	1.33	76.66	2760
CORNER/COLUMN							
6 X 18 X 9	36	9	4	32	0.88	95.06	3042
CAP							
3 X 18 / 12 X 13	78.75 LF	11.25 LF	7	63	1.25 LF	58.73	3700



RADIUS PATTERNS

PATTERN	NUMBER OF UNITS AND REPEAT	INSIDE DIAMETER	OUTSIDE RADIUS
1	8 SMALL / 8 MEDIUM / 7 LARGE	54"	39"
2	13 SMALL / 15 MEDIUM	59"	41.5"
3	13 LARGE	49"	36.5"
NOT SHOWN	1 MEDIUM / 22 LARGE	114"	69"

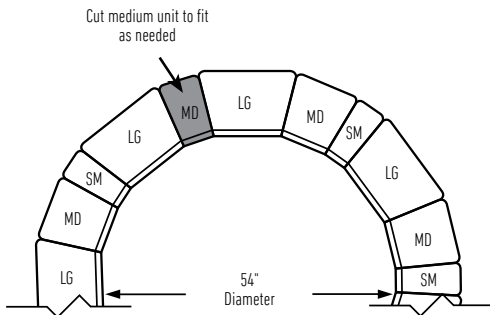

PATTERN 1

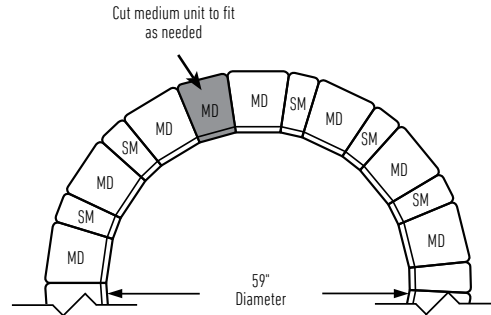

PATTERN 2

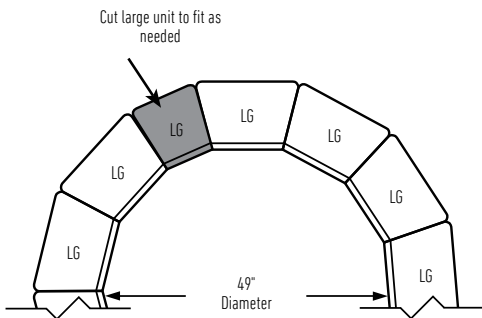

PATTERN 3





KEY
SM = Small
MD = Medium
LG = Large

NOTE: To split a block, use a hydraulic splitter or split manually by using a hammer and chisel to score the block on all sides. Pound the chisel on the same line until the block splits. If partial unit sides are not exposed, use a saw with a diamond blade to achieve a tighter fit.







Scan for additional
product information

NOTE: For walls over 30 inches in height, soil reinforcement is generally necessary.
A qualified engineer should be consulted for design and analysis of structures.

RESIDENTIAL	COMMERCIAL	STEPS	COLUMNS	FIRE PITS	KITCHEN	FREESTANDING WALL	RETAINING WALL
							
✓	✓	✓	✓	✓	✓	✓	✓

SHAPES & SIZES

3-Piece	Cap	Modular Block	U Start Base Block
			
7 x 13 ³ / ₁₆ x 2 ⁵ / ₈	15x 24 x 3 ¹ / ₄	7 ¹ / ₁₆ x 7 ⁷ / ₈ x 7 ⁷ / ₈ <i>(Connectors included)</i>	12 x 18 ¹ / ₂ x 3 ¹ / ₂ <i>(Recommended for all installations)</i>

UNIT	SQFT/ PALLET	SQFT/ LAYER	LAYER/ PALLET	UNITS/ PALLET	UNITS/ SQFT	WEIGHT/ UNIT	WEIGHT/ PALLET
------	-----------------	----------------	------------------	------------------	----------------	-----------------	-------------------

3-PIECE

7 X 13 ³ / ₁₆ X 2 ⁵ / ₈	19.2	3.2	–	30	1.56	18.23	546.82
7 X 15 ¹³ / ₁₆ X 2 ⁵ / ₈	23.55	3.92	–	30	1.27	22.36	671
7 X 18 ⁷ / ₁₆ X 2 ⁵ / ₈	27.35	4.56	–	30	1.09	26.04	781.48
TOTAL	70.1	11.68	6	90	–	–	2003

CAP

15 X 24 X 3 ¹ / ₄	64 LF	8 LF	8	32	0.5 LF	95.31	3050
---	-------	------	---	----	--------	-------	------

MODULAR BLOCK

7 ¹ / ₁₆ X 7 ⁷ / ₈ X 7 ⁷ / ₈	49.29	-	4	128	0.389	22	2816
--	-------	---	---	-----	-------	----	------

U START BASE BLOCK®

12 X 18 ⁷ / ₁₆ X 3 ¹ / ₂	77.88 LF	11.13 LF	7	56	0.72	54	3080
--	----------	----------	---	----	------	----	------



Scan for additional
product information

NOTE: For walls over 20 inches in height, soil reinforcement is generally necessary.
A qualified engineer should be consulted for design and analysis of structures.

RESIDENTIAL	COMMERCIAL	STEPS	COLUMNS	FIRE PITS	KITCHEN	FREESTANDING WALL	RETAINING WALL
							
✓	✓	✓	✓	✓	✓	✓	✓

SHAPES & SIZES

Wall Unit

Cap*



4 x 20 x 10

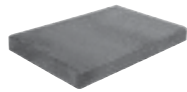

2 x 20 x 13

* Can be used as cap and/or wall block
NOTE: Some units may include channels for lighting.









UNIT	LNFT/ PALLET	LNFT/ LAYER	LAYER/ PALLET	UNITS/ PALLET	UNITS/ SQFT	WEIGHT/ UNIT	WEIGHT/ PALLET
WALL UNIT							
4 X 20 X 10	26.67	4.44	6	48	1.8	48.75	3120
CAP							
2 X 20 X 13	120 LF	10 LF	12	72	0.6 LF	43.33	3100





Scan for additional product information

NOTE: For walls over 30 inches in height, soil reinforcement is generally necessary. A qualified engineer should be consulted for design and analysis of structures.

RESIDENTIAL	COMMERCIAL	STEPS	COLUMNS	FIRE PITS	KITCHEN	FREESTANDING WALL	RETAINING WALL
							
✓			✓		✓	✓	✓

SHAPES & SIZES

Wall Units

Cap



6 x 6 / 4 x 10



6 x 12 / 10 x 10



6 x 16 / 10 x 14



3 x 12 / 8 x 12

NOTE: Pins are included

UNIT	SQFT/PALLET	SQFT/LAYER	LAYER/PALLET	UNITS/PALLET	UNITS/SQFT	WEIGHT/UNIT	WEIGHT/PALLET
------	-------------	------------	--------------	--------------	------------	-------------	---------------

WALL UNITS

6 X 6 / 4 X 10	4.99	0.83	–	24	4.8	22	528
6 X 12 / 10 X 10	10.99	1.83	–	24	2.18	48	1152
6 X 16 / 14 X 10	15	2.5	–	20	1.6	66	1584
TOTAL	31	5.16	6	72	–	–	3264

CAP









3 X 12 / 8 X 12	60 LF	10 LF	6	72	1.2 LF	28.32	2039
-----------------	-------	-------	---	----	--------	-------	------





Scan for additional
product information

NOTE: For walls over 30 inches in height, soil reinforcement is generally necessary. A qualified engineer should be consulted for design and analysis of structures.

RESIDENTIAL	COMMERCIAL	STEPS	COLUMNS	FIRE PITS	KITCHEN	FREESTANDING WALL	RETAINING WALL
							
✓			✓		✓	✓	✓

SHAPES & SIZES

Wall Units

Cap



6 x 6 / 4 x 10



6 x 12 / 10 x 10



6 x 16 / 14 x 10



3 x 12 / 8 x 12

NOTE: Pins are included

UNIT	SQFT/ PALLET	SQFT/ LAYER	LAYER/ PALLET	UNITS/ PALLET	UNITS/ SQFT	WEIGHT/ UNIT	WEIGHT/ PALLET
------	-----------------	----------------	------------------	------------------	----------------	-----------------	-------------------

WALL UNITS

6 X 6 / 4 X 10	4.99	0.83	–	24	4.8	22	528
6 X 12 / 10 X 10	10.99	1.83	–	24	2.18	48	1152
6 X 16 / 14 X 10	15	2.5	–	20	1.6	66	1584
TOTAL	31	5.16	6	72	–	–	3264

CAP

3 X 12 / 8 X 12	60 LF	10 LF	6	72	1.2 LF	28.32	2039
-----------------	-------	-------	---	----	--------	-------	------



SHELTON WALL AND STEEPLE CREST - LAYING PATTERN GUIDE FOR MULTI HEIGHT RETAINING WALLS

WHEN TO USE A PATTERN

You can install the multipiece retaining wall system in a random pattern using any combination of units. Just avoid vertical lines that span more than 1 foot in height. If you are building a wall without geosynthetic reinforcement, use a pattern for inspiration or follow the pattern exactly. Pleasing random patterns can be built using an equal number of 6- and 3-inch high blocks or using an equal square footage of blocks in each size. These patterns are based on using an equal number of blocks of each size in each height.

When building a wall that includes geosynthetic reinforcement, using a pattern at the appropriate spacing eliminates the need to cut the geogrid. When using a pattern, begin at one edge laying the blocks as indicated. Install at least one repeat of the pattern to establish the pattern before proceeding to the next course.

SEQUENT™ PANEL INSTALLATION PATTERN



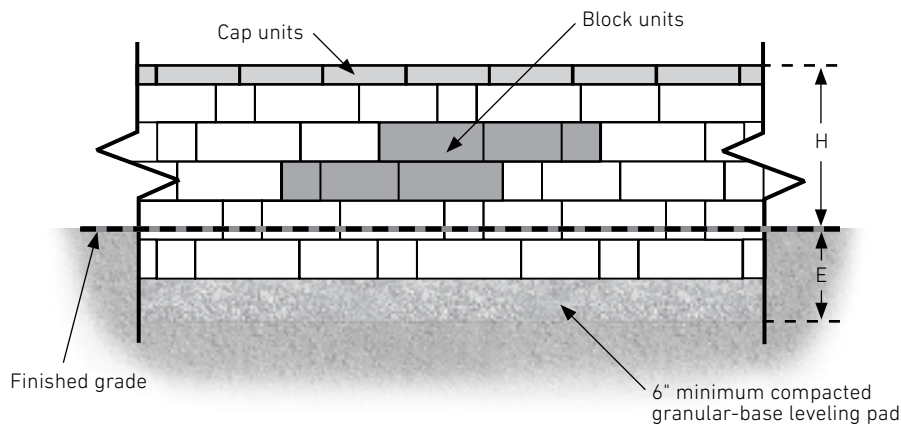





9-inch by 5-foot 8-inch Installation Pattern. This 9-inch high by 34-inch long installation pattern uses an equal number of units of each face size to make the panel. This installation pattern is one of many possible options. Others can be used for different appearances.





Scan for additional product information

NOTE: For walls over 30 inches in height, soil reinforcement is generally necessary. A qualified engineer should be consulted for design and analysis of structures.

RESIDENTIAL	COMMERCIAL	STEPS	COLUMNS	FIRE PITS	KITCHEN	FREESTANDING WALL	RETAINING WALL
							
✓	✓	✓	✓	✓	✓	✓	✓

SHAPES & SIZES

Universal



4 x 8 x 12

UNIT	SQFT/PALLET	SQFT/LAYER	LAYER/PALLET	UNITS/PALLET	UNITS/SQFT	WEIGHT/UNIT	WEIGHT/PALLET
UNIVERSAL							
4 X 8 X 12	33.5	6.7	5	100	2.98	28.99	2899



WESTON STONE™ INSTALLATION INSTRUCTIONS

This is a pinless system. Maximum wall height is 2½ feet. Walls exceeding 2½ feet in height may require geogrid reinforcing and the consultation of a qualified engineer. Contact your Belgard sales representative or dealer for assistance.

Weston Stone wall units must be glued with a quality construction adhesive to develop the necessary mechanical bond. All measurements herein are approximate. Natural materials are used in the manufacturing of this product.

WESTON STONE™ WALL PATTERNS

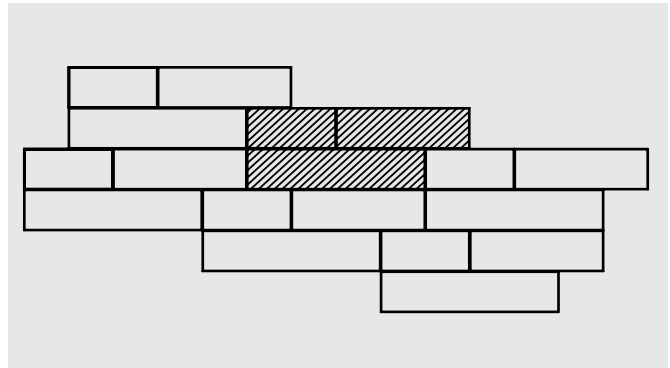
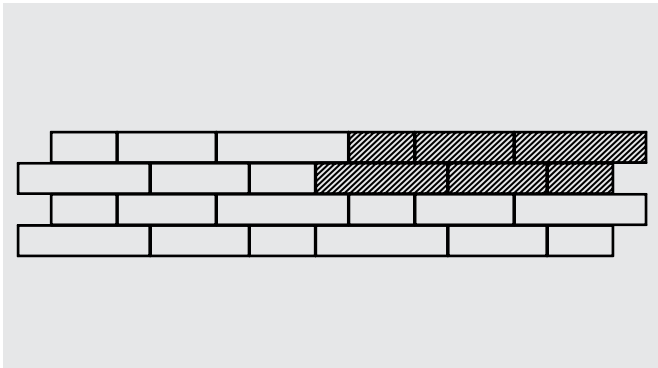

TYPICAL CROSS SECTION WITH WESTON STONE SEAT WALL

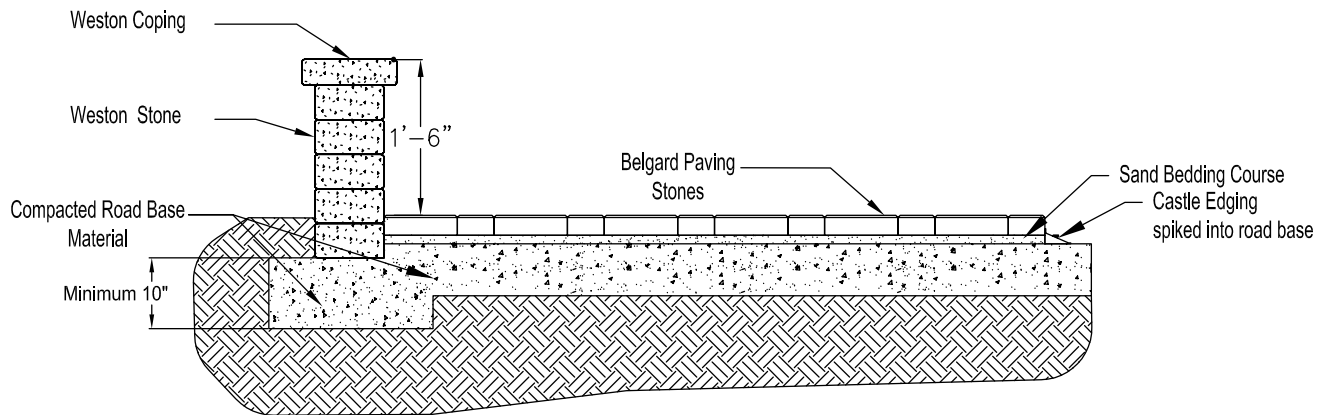

TREE RINGS WITH WESTON STONE

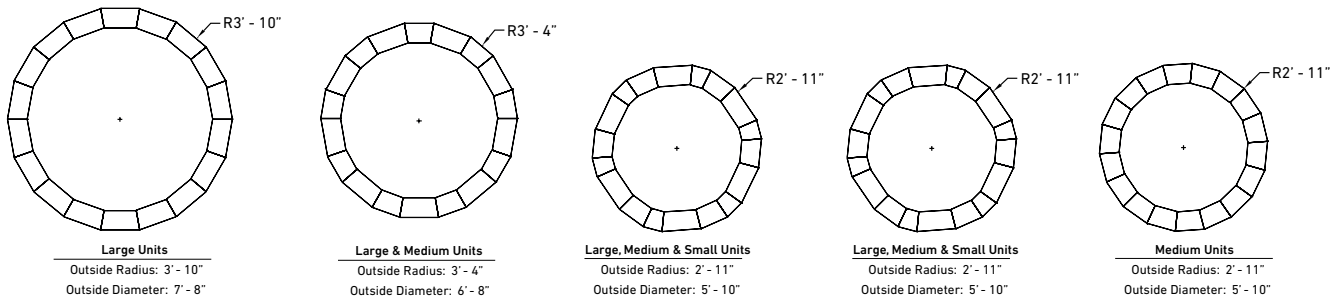

FIRE FEATURES



FIRE FEATURES INSTALLATION GUIDE

126 Installation Instructions

FIRE FEATURES

127 Weston Stone™ Fire Pit Kit

STANDARD INSTALLATION INSTRUCTIONS

GRAVEL BASE

Gravel Fill shall be a clean angular stone or angular granular fill meeting the following gradation as determined in accordance with ASTM D 422.

Sieve Size	Percent Passing
1-in	100
3/4-in	75-100
No. 4	0-60
No. 40	0-50
No. 200	0-12

FOUNDATION PREPARATION

Following excavation of the leveling pad, foundation soil shall be examined to assure the actual foundation soil strength meets or exceeds the assumed design bearing strength. Soils not meeting the required strength shall be removed and replaced with soil meeting the design criteria.



*Scan for Fortified Installation Method
to be used with soft soils or expanding clays*

LEVELING PAD PREPARATION

A minimum 18-in thick layer or compacted granular material shall be placed for use as a leveling pad up to the grades and locations as shown on the construction drawings. The granular base shall be compacted to a firm, level bearing pad on which to place the bottom level of the unit. A leveling pad consisting of 6-in (minimum) thick lean, unreinforced concrete may be used at the contractor's option, or if so detailed on the plans. The leveling pad should extend a minimum of 6-in from the toe and from the heel of the unit base.

GRAVEL FILL

Gravel fill shall be placed to the minimum finished thickness and width shown on the construction plans.

Gravel lifts shall be a maximum thickness of 6-in.









Lifts shall be compacted by three passes of a light weight vibratory plate compactor.

For areas not affected by freeze-thaw conditions please contact your local Belgard sales representative for further installation information.

WESTON STONE™ FIRE PIT KIT



Scan for additional
product information

RESIDENTIAL	COMMERCIAL	STEPS	COLUMNS	FIRE PITS	KITCHEN	FREESTANDING WALL	RETAINING WALL
							
✓				✓			

SHAPES & SIZES

Fire Pit Unit



4 x 8 x 8

UNIT	SQFT/ PALLET	SQFT/ LAYER	LAYER/ PALLET	UNITS/ PALLET	UNITS/ LAYER	UNITS/ SQFT	WEIGHT/ PALLET
FIRE PIT UNIT							
4 X 8 X 8	-	-	-	36	9	-	1025

FIRE PIT KITS INSTALLATION INSTRUCTIONS

- Always use in accordance with all applicable local and state fire codes
- Failure to follow these instructions could result in a hazardous fire causing property damage or physical injury
- Caution: For outdoor use only
- Use the fire ring on stone, dirt or sand surfaces
- For adult use only — do not allow children to use the fire ring
- Do not use on lawns, wooden decks, concrete or asphalt
- Do not use fire ring indoors or under a patio roof
- Do not use in windy conditions
- Do not leave fire unattended at any time
- Do not use under tree branches, trellis, or overhangs of any kind, including covered porches
- Do not use flammable liquids such as gasoline, alcohol, diesel fuel, kerosene, or charcoal lighter fluid to light or relight fires as this may also cause paint to flake off fire ring
- Care should be taken to make sure all combustible material is far enough away from the fire ring not to ignite it
- Avoid using softwoods such as pine or cedar because they are likely to throw sparks — hardwoods are recommended
- Keep children and pets away from the fire ring while it is in use
- Exercise the same precautions you would with any open fire
- Do not wear flammable or loose clothing when tending an open fire
- Avoid touching surfaces as they will be extremely hot
- Assure the fire is completely extinguished before leaving fire ring
- Any modifications to this appliance may be dangerous and are not permitted

ADDITIONAL MATERIALS NEEDED

- Tamper
- Level
- 2 Bags of Leveling Sand
- 2 Tubes of Concrete Adhesive
- Caulk Gun
- 3 Bags of Gravel or Lava Rock
- Shovel
- Optional Marking Paint or Chalk









ACCESSORIES

ACCESSORIES

- 130 Anglia Edger®
- 132 Artforms™
- 134 Column Cap
- 135 Landings™ Step Unit
- 138 Marina™ Coping
- 140 Melville™ Curb
- 141 Unico Coping



Scan for additional
product information

RESIDENTIAL	COMMERCIAL	STEPS	CAPS	FIRE PITS	KITCHEN	FREESTANDING WALL	RETAINING WALL
							
✓	✓						

SHAPES & SIZES

Edger Units



5 1/4 x 8 x 8



5 1/4 x 10 1/2 x 8



5 1/4 x 15 5/8 x 8



5 1/4 x 18 x 8

UNIT	LNFT/ PALLET	LNFT/ LAYER	LAYER/ PALLET	UNITS/ PALLET	UNITS/ LAYER	UNITS/ LNFT	WEIGHT/ PALLET
------	-----------------	----------------	------------------	------------------	-----------------	----------------	-------------------

EDGER UNITS





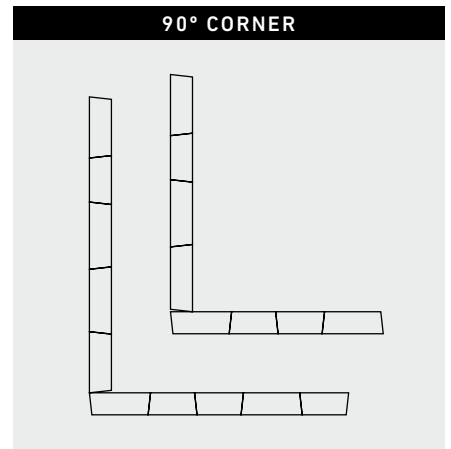
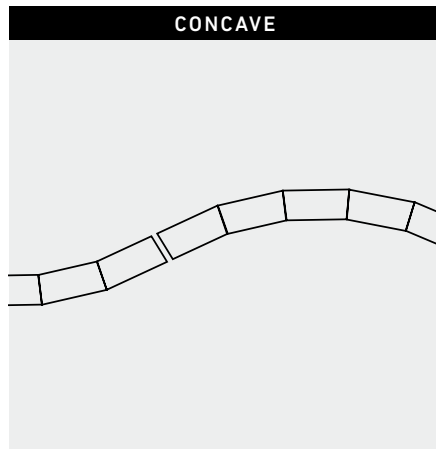
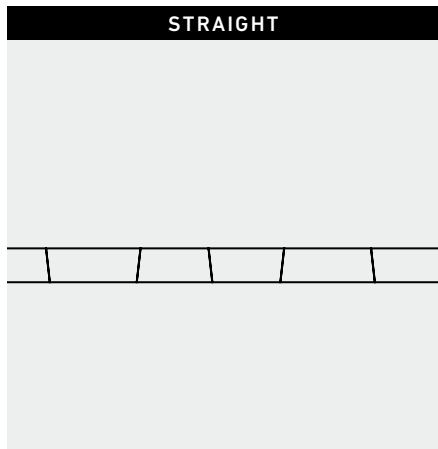
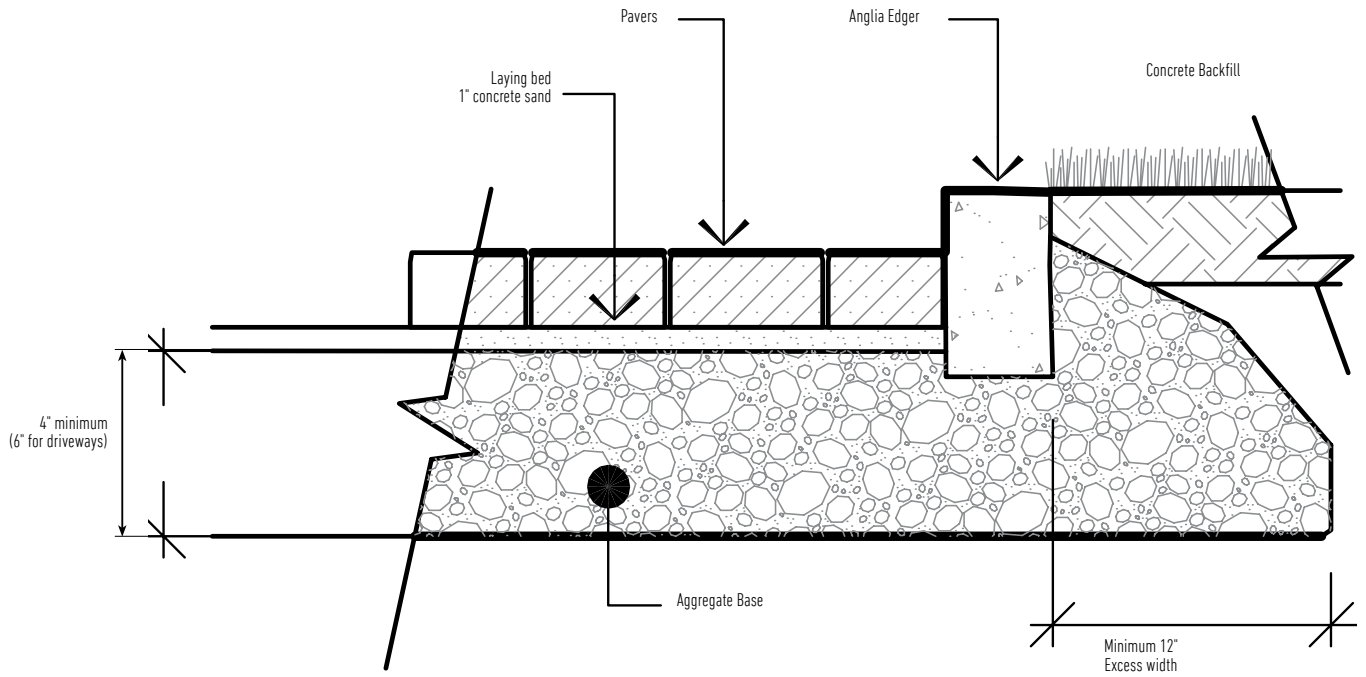



5 1/4 X 8 X 8	7.9	2.63	–	12	1.52	24.29	291.5
5 1/4 X 10 1/2 X 8	10.5	3.5	–	12	1.14	35.33	424
5 1/4 X 15 5/8 X 8	15.6	5.2	–	12	0.76	48.58	583
5 1/4 X 18 X 8	35.75	11.92	–	24	0.67	56.31	1351.5
TOTAL	69.75	23.25	3	60	–	–	2650

ANGLIA EDGER INSTALLATION INSTRUCTIONS





Scan for additional product information

RESIDENTIAL	COMMERCIAL	STEPS	CAPS	FIRE PITS	KITCHEN	FREESTANDING WALL	RETAINING WALL
							
✓	✓			✓	✓		

SHAPES & SIZES

18 x 36*

6 x 36*†

Installation Hardware



3 x 18 x 36

*Pallets contain both open and closed ended units



3 x 6 x 36

†Contact your Belgard representative for availability on 6x36

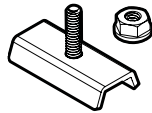

Anchor & Nut
50 per box

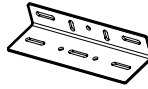

10 per box

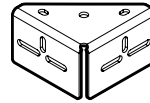

Outer Corner
10 per box

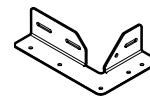

Inner Corner
10 per box

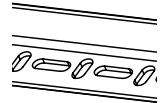

Stretcher
10 per box

UNIT	SQFT/PALLET	SQFT/LAYER	LAYER/PALLET	UNITS/PALLET	UNITS/LAYER	WEIGHT/LAYER	WEIGHT/PALLET
------	-------------	------------	--------------	--------------	-------------	--------------	---------------

ARTFORMS

3 X 18 X 36	81	9	9	18*	2	305	2745***
3 X 6 X 36	31.5	10.5	3	21*	7	365	1095

*Total number of both open and closed end panels. 18 x 36 pallets contain 9 of each. 6 x 36 pallets contain 3 open end panels and 18 closed end panels
***150lbs is the weight for the closed units, 148lbs is the weight for the open units.

18 X 36 X 3

6 X 36 X 3

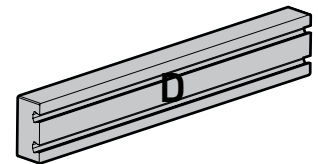
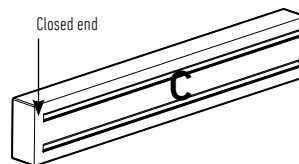
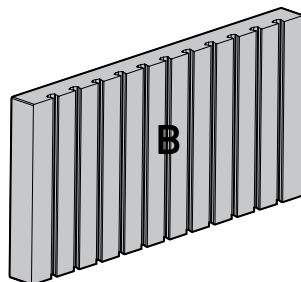
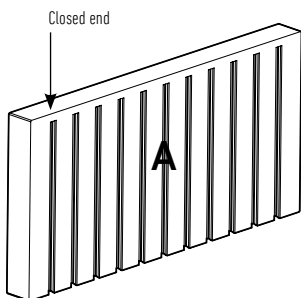

PANEL CONFIGURATIONS

IDEAL:

This configuration uses equal number of panel A and panel B.

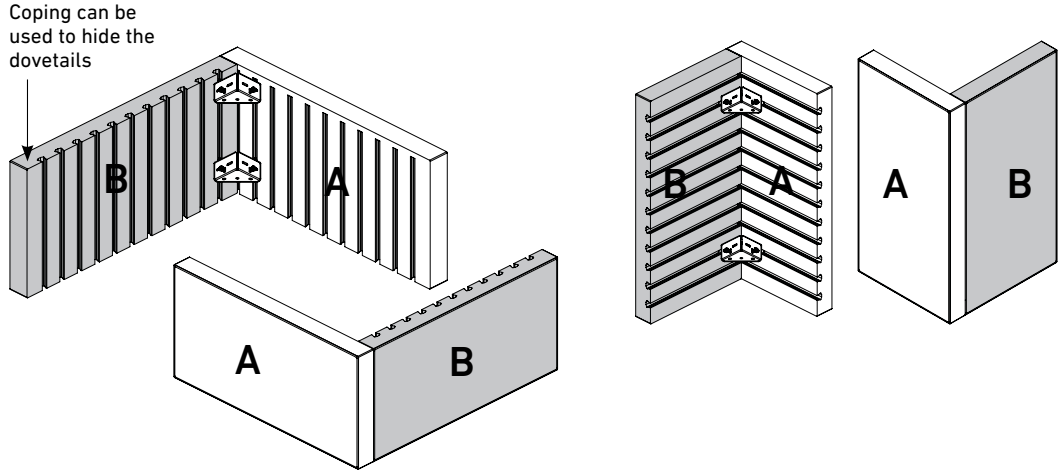

NOT OPTIMAL:

This configuration uses panel A only.

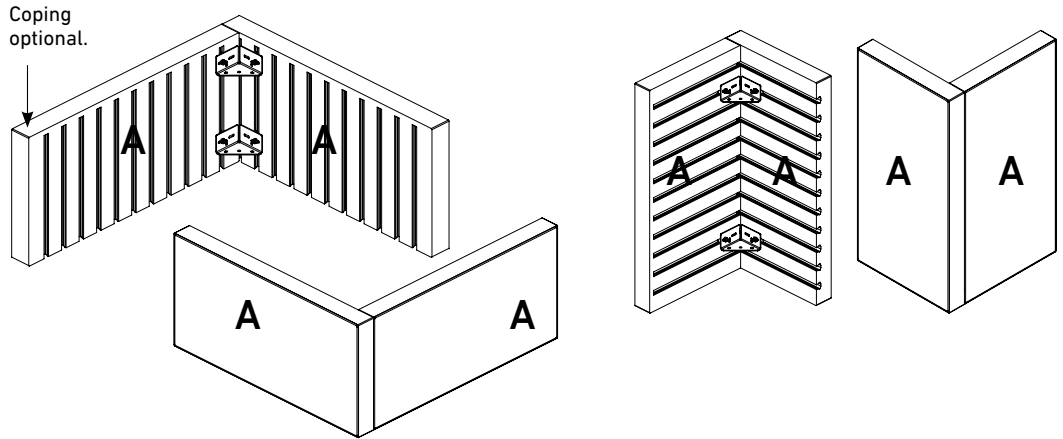

NOT RECOMMENDED:

This configuration uses panel B only and the dovetails are exposed. Use ideal configuration as shown above.

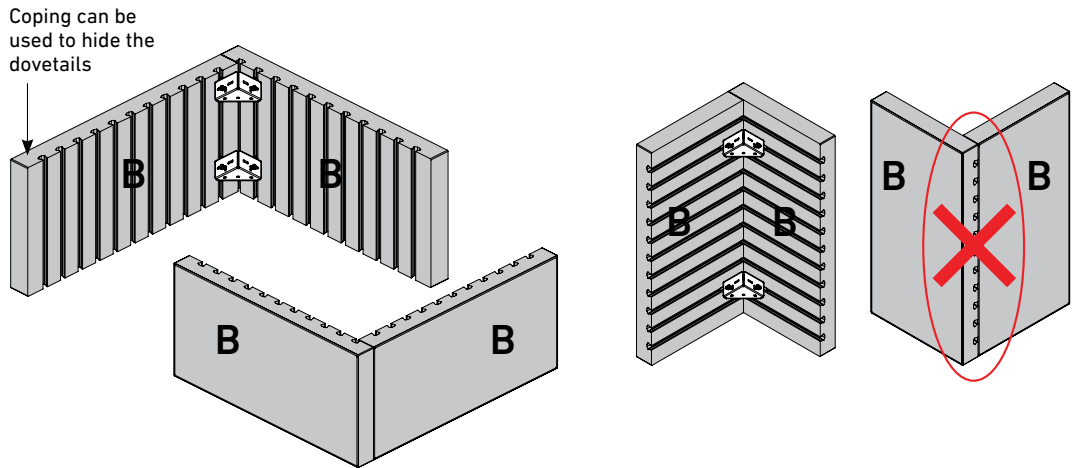







*IMPORTANT: When planning configurations, consider the amount of panel A and panel B on a pallet. 18 x 36' panels are sold in pair/layer or in full pallet only. 6 x 36 panels are sold in layer or in full pallet only.

COLUMN CAP



Scan for additional product information

RESIDENTIAL	COMMERCIAL	STEPS	CAPS	FIRE PITS	KITCHEN	FREESTANDING WALL	RETAINING WALL
							
✓			✓				

SHAPES & SIZES

Cap



28 x 28 x 3





UNIT	LNFT/ PALLET	LNFT/ LAYER	LAYER/ PALLET	UNITS/ PALLET	UNITS/ LAYER	WEIGHT/ UNIT	WEIGHT/ PALLET
CAP							
28 X 28 X 3	-	-	-	4	-	254	1016



LANDINGS™ STEP UNIT



Scan for additional
product information

RESIDENTIAL	COMMERCIAL	STEPS	CAPS	COPING
				
✓	✓	✓	✓	

SHAPES & SIZES

Step Unit



6 x 48 x 18

UNIT	LNFT/ PALLET	LNFT/ LAYER	LAYER/ PALLET	UNITS/ PALLET	UNITS/ LAYER	WEIGHT/UNIT	WEIGHT/ PALLET
STEP UNIT							
6 X 48 X 18	24	-	6	6	2	454.47	2726.82



LANDINGS™ STEP UNIT INSTALLATION

Each Landings™ Step Unit is manufactured with two unique face patterns. The step units are palletized and packaged for easy skid-steer loader removal. Care needs to be taken in handling these units. If a blemish occurs on one side of unit, rotate 180° before setting unit into place.

BASE COURSE

Excavate an area 6 inches deep by 1 foot longer by 1 foot wider than the installed step(s) size. Add a minimum of 6 inches of compactable base material, 3/4-inch minus (with fines) aggregate. Compact and level. Set unit and, if desired, add a slight pitch of no more than 1/4 inch toward the front of the step to shed moisture. If installing step units next to a retaining wall, keep units level from front to back.

The Textures on Sides 1 and 2 are Designed to Nest with Minimal Gapping Between the Units.

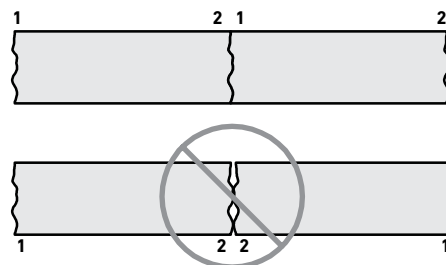

Place Units so They Nest Tightly Together.



Two unique faces on each step

STAIR TREAD

For each consecutive step, follow base course instructions, making sure the top of the base is even with the top of the previously installed unit. Recommended tread depth is a minimum of 10 inches, but no more than 16 inches. When installing steps adjacent to a finished surface such as pavers, as illustrated, a 6-inch-tall dummy block needs to be installed below the first step.

LANDING

For landing(s) follow base course instructions. Each step unit is manufactured with two unique face patterns. The face patterns are manufactured to nest together, which will create a narrower joint, providing pleasing aesthetics.

STEPS IN A 90-DEGREE WALL

When building into a retaining wall, construct the steps first and build the walls adjacent to the steps.

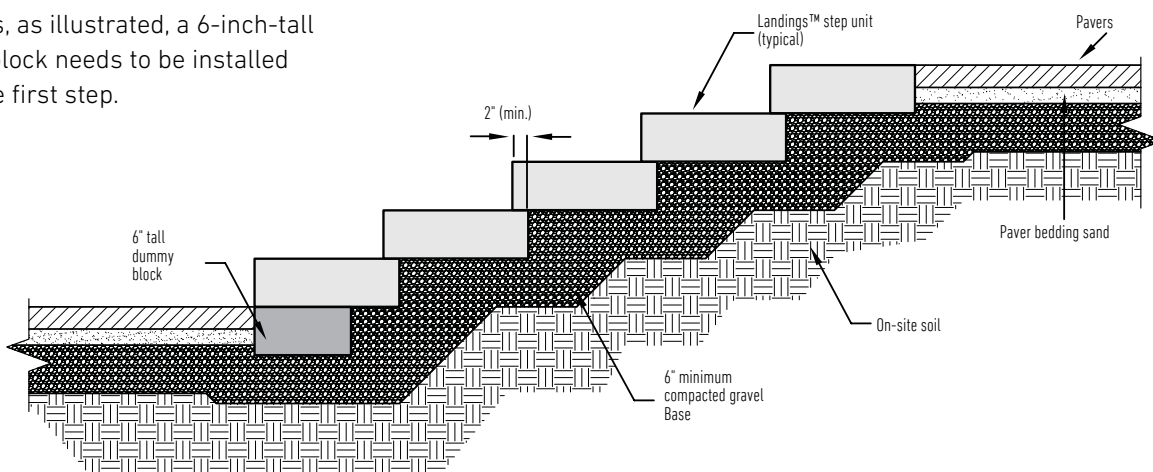

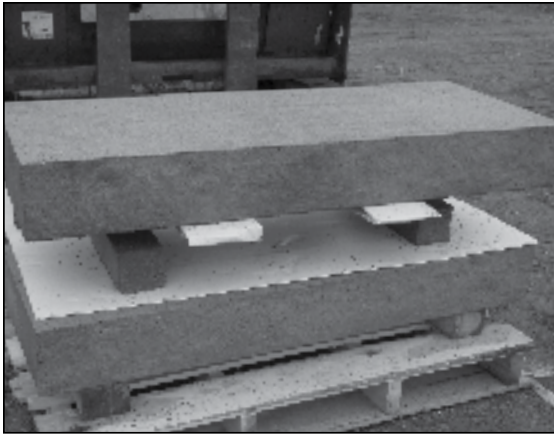

SKID-STEER LOADER

Slide forks underneath the first step unit and lift off pallet. Set the step unit onto its desired location, using a spacer to ease in fork removal.



A helpful tip to protect the step unit is to wrap the fork of the skid-steer with corrugated plastic packaging from the pallet or other protective materials. Secure to the forks.



CLAMP

Using a materials clamp, center the clamp on the step unit. Attach clamp to skid-steer or mini-excavator and slowly lift the step unit off of the pallet and move it into place. Be sure to have a second person to help guide the unit into place as the machine sets the step unit down.



STRAPS

When using a heavy duty strap(s), start by wrapping the strap(s) around the center if using one or close to step unit ends if two straps are being used. Cinch the strap(s) tight and attach the looped ends of the strap(s) to skid-steer or mini-excavator. Slowly lift the step unit from the pallet and move it into place. Be sure to have a second person to help guide the unit into place as the machine sets the step unit down. Using a spacer will help to ease in the strap removal.

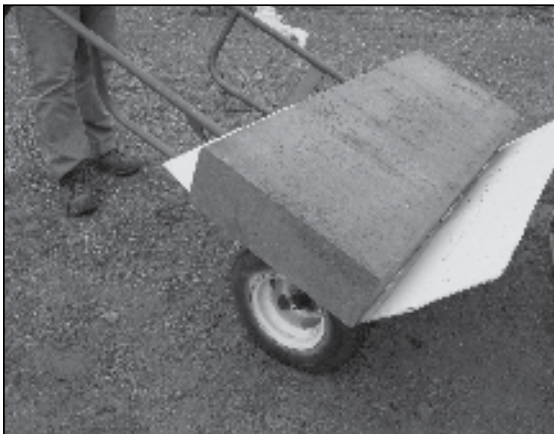

CART





When using a cart, place provided corrugated plastic from pallet or other protective material onto the cart to help protect the step unit. With help from a second person, slowly slide the step unit from the pallet onto the cart. Maneuver the unit carefully into place.

Videos can be found on our YouTube channel:
www.youtube.com/anchorblockmn

MARINA™ COPING



Scan for additional product information

RESIDENTIAL	COMMERCIAL	STEPS	CAPS	COPING
				
✓		✓	✓	✓

SHAPES & SIZES

60mm

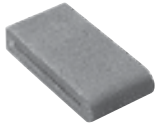

6 x 12 x 2³/₈

UNIT	SQFT/ PALLET	SQFT/ LAYER	LAYER/ PALLET	UNITS/ PALLET	UNITS/ LAYER	UNITS/ SQFT	WEIGHT/ PALLET
60MM							
6 X 12 X 2³/₈	63	21	3	126	42	2	1760

MARINA COPING - POOL INSTALLATION

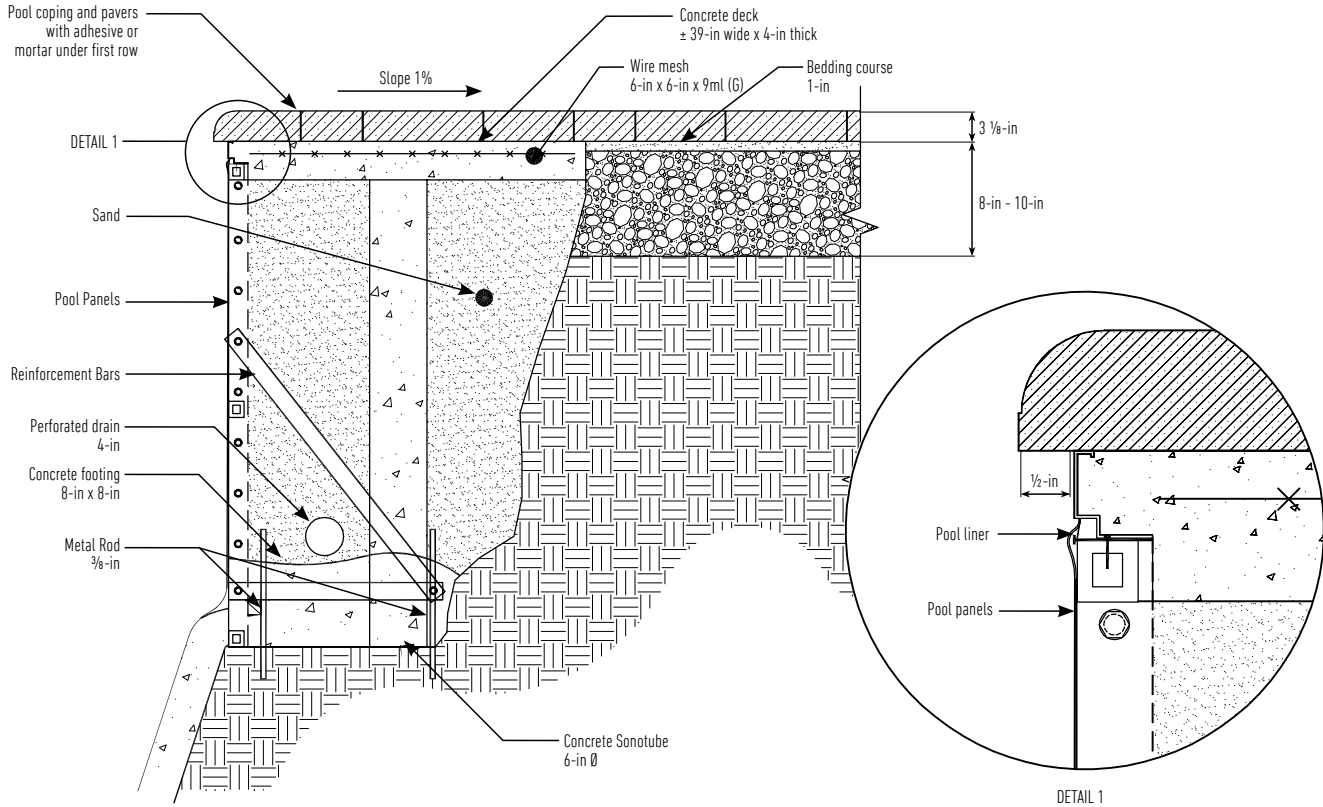

MARINA COPING - STEP INSTALLATION

OPTION 1

- A. Marina Coping
- B. Wall Block
- C. Grey block (4 in x 8 in x 16 in) or Wall Block

Note: All elements must be glued together with the concrete adhesive

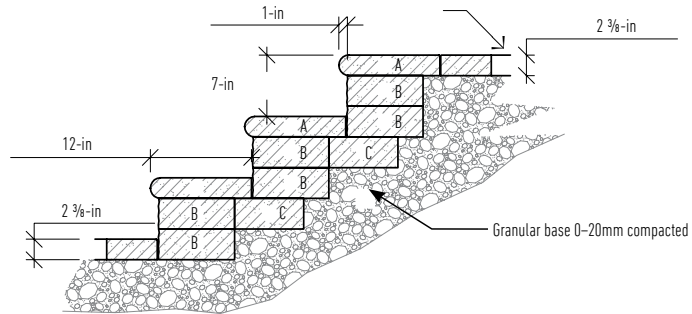

OPTION 2



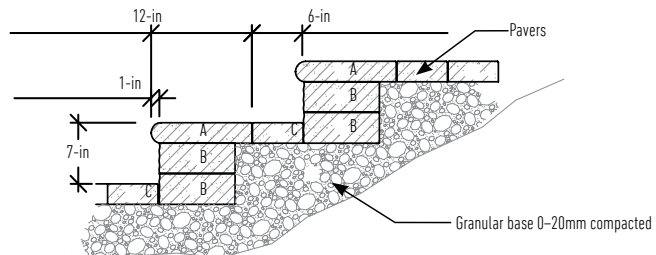

- A. Marina Coping
- B. Wall Block

Note: A & B elements must be glued together with the concrete adhesive.





Scan for additional
product information

RESIDENTIAL	COMMERCIAL	STEPS	CAPS	COPING
				
✓	✓			

SHAPES & SIZES

Curb



4 x 24 x 6½





UNIT	LNFT/ PALLET	LNFT/ LAYER	LAYER/ PALLET	UNITS/ PALLET	UNITS/ LAYER	UNITS/ LNFT	WEIGHT/ PALLET
CURB							
4 X 24 X 6½	96	24	4	48	12	0.5	2480

UNICO COPING

PORCELAIN
COLLECTION 



Scan for additional
product information

RESIDENTIAL	COMMERCIAL	STEPS	CAPS	COPING
				
✓		✓		✓

Coping Unit

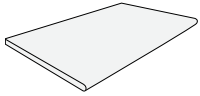

12.99 x 23.54 x 3/4

UNIT	WEIGHT/BOX	PIECES/BOX	LNFT/ BOX	BOXES/PALLET	LNFT/ PALLET	WEIGHT/ PALLET
COPING						
12.99 X 23.54 X 3/4	52	3	6	40	240	2080

MIRAGE
INSPIRING BETTER LIVING

BELGARD® | PAVES
THE WAY®

OLDCASTLE PACIFIC
10714 Poplar Ave
Fontana, CA 92337
Ph: 909-355-6422

STAY CONNECTED WITH BELGARD.

-  [Pinterest.com/Belgard](https://www.pinterest.com/Belgard)
-  [Facebook.com/OutdoorLivingbyBelgard](https://www.facebook.com/OutdoorLivingbyBelgard)
-  [Belgard.com/Blog](https://www.belgard.com/blog)
-  [YouTube.com/BelgardHardscapes](https://www.youtube.com/BelgardHardscapes)
-  [Twitter.com/Belgard](https://twitter.com/Belgard)
-  [Instagram.com/BelgardOutdoorLiving](https://www.instagram.com/BelgardOutdoorLiving)